

Construction & Material Handling Tyres

Technical Catalogue

Edition 2020/2021





Mitas Technical Catalogue for Construction & Material Handling Tyres – Edition 2020 / 2021

The extensive technical data and other information relating to tyres and accessories on the following pages has been compiled to reflect as accurately and completely as possible the current state of development. Due to changes in our product range the tyre sizes given in this guide are not always identical to our available range.

Mitas, part of Yokohama group, is one of Europe's leading tyre brands for agricultural machines, construction vehicles, material handling equipment, motorcycles and other specialty segments. Mitas tyres are being produced in the Czech Republic, the United States, Serbia, Slovenia, Sri Lanka and promoted through a global sales and distribution network.

For further information please contact us:

Yokohama TWS Czech Republic a.s.

Švehlova 1900/3, 106 00 Prague 10, Czech Republic

Contents

Tread patterns, markings and definitions

List of tread patterns	4
List of tyre sizes	6
Tyre size marking	8
Speed symbols and conversion tables	9
Tyre sidewall marking and structures	10
Load index	11

Earthmover Tyres

EM – Earthmover Radial–Light equipment	12
EM – Earthmover Diagonal	18
Light Equipment Diagonal	26
Excavator	34
Roller & Tractor Grader	38

Crane Tyres

CR – Crane Radial	44
-------------------	----

Multipurpose Tyres

MPT– Multipurpose Radial	48
MPT– Multipurpose Diagonal	54

Tractor Industrial Tyres

TI – Tractor Industrial Radial	58
Construction Applications Diagonal	62

Skid Steer Tyres

SK – Skid Steer	74
-----------------	----

Material Handling Tyres

FL – Material Handling Diagonal	80
---------------------------------	----

Use and Maintenance	88
Fitting and removal instructions	89
Earthmover tyres general information	90
List of homologations	93
Rim specification	94
Terms and abbreviations used in this catalogue	98

Tread patterns



Legend:

Earthmover Tyres

Page 12

Crane Tyres

Page 44

Multipurpose Tyres

Page 48

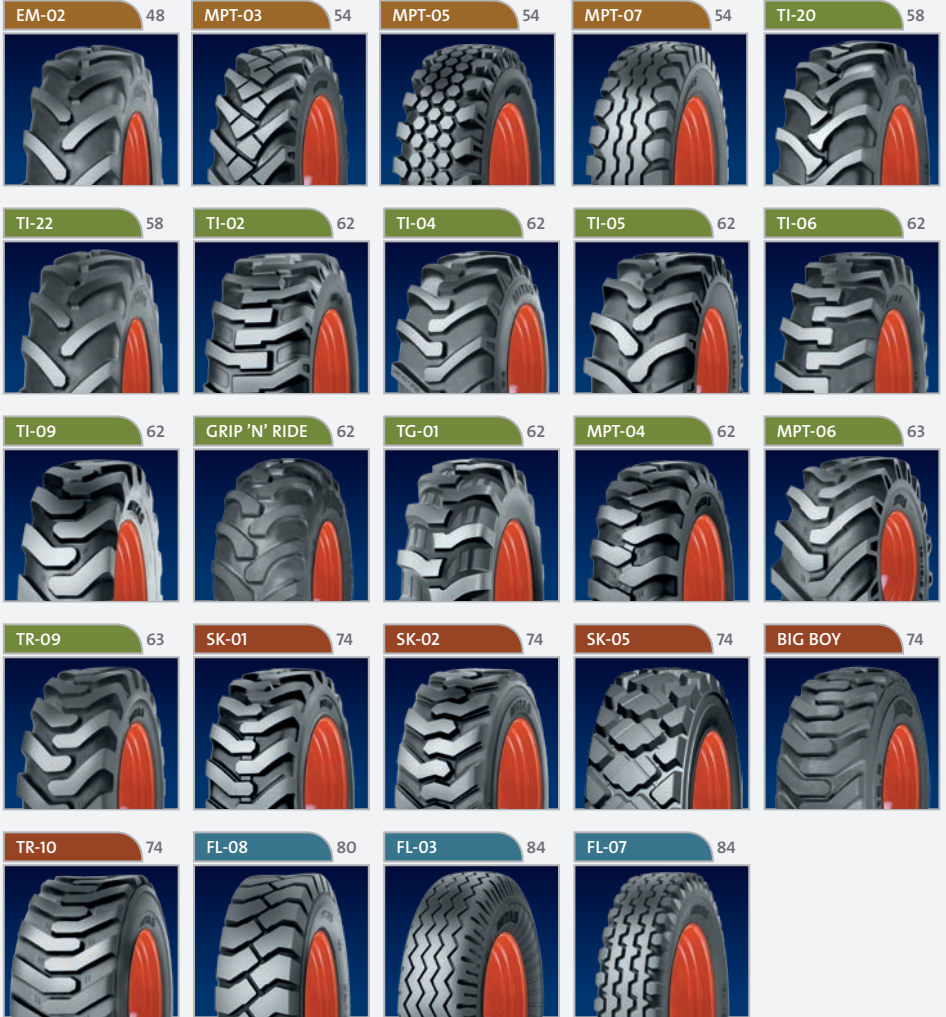

List of tyre sizes

Size (inch)	Tyre size (Alternative tyre size)	Tread pattern	Page
EM Radial Tyres			
18"	335/80 R 18 (12.5 R 18)	EM-02	14
	365/70 R 18	EM-01	14
	405/70 R 18 (16/70 R 18)	EM-01	14
20"	335/80 R 20 (12.5 R 20)	EM-01	14
	365/80 R 20 (14.5 R 20)	EM-01	14
	405/70 R 20 (16/70 R 20)	EM-01	14
24"	405/70 R 24 (16/70 R 24)	EM-01	16
	440/70 R 24 (17.5L R 24)	EM-02	16
	500/70 R 24	EM-01	16
EM Diagonal Tyres			
24"	20 - 24 (22/70 - 24)	EM-70	20
25"	15.5 - 25	EM-20	20
	15.5 - 25	EM-60	20
	15.5 - 25	EM-80	20
	17.5 - 25	EM-20	20
	17.5 - 25	EM-30	20
	17.5 - 25	EM-60	20
	18.00 - 25	NB 38	22
	20.5 - 25	EM-20	22
	20.5 - 25	EM-30	22
	20.5 - 25	EM-60	22
	23.5 - 25	EM-20	22
	23.5 - 25	EM-30	22
	23.5 - 25	EM-60	22
	26.5 - 25	EM-30	24
	26.5 - 25	EM-60	24
29"	26.5 - 29	NB-57	24
Light Equipment Diagonal Tyres			
18"	280/80 - 18 (10.5-18)	MPT-01	28
	10.5 - 18	MPT-02	28
	340/80 - 18 (12.5-18)	MPT-01	28
19.5"	18 - 19.5	MPT-02	28
	18 - 19.5	MPT-03	30
	18 - 19.5	MPT-06	30
20"	18 - 19.5	MPT-08	30
	10.5 - 20	MPT-04	30
	340/80 - 20 (12.5-20)	MPT-01	30
24"	16/70 - 20 (405/70-20)	MPT-02	30
	405/70 - 20 (16/70-20)	MPT-01	32
	405/70 - 24 (16/70-24)	MPT-01	32
	405/70 - 24	MPT-04	32
Excavator Tyres			
20"	8.25 - 20	NB 38	36
	8.25 - 20	NB 38 Extra ML	36
	9.00 - 20	NB 38	36
	9.00 - 20	NB 38 Extra ML	36
	9.00 - 20	EM-22	36
	10.00 - 20	NB 38	36

Size (inch)	Tyre size (Alternative tyre size)	Tread pattern	Page
	10.00 - 20	NB 38 Extra ML	36
	10.00 - 20	EM-22	36
	10.00 - 20	EM-23	36
	11.00 - 20	NB 38	36
	11.00 - 20	EM-22	36
	500/45 - 20	TI-12	36
22.5"	315/80 R 22.5	EX-01	36
	500/60 - 22.5	TI-12	36
	600/40 - 22.5	TI-12	36
Roller & Tractor Grader Tyres			
15"	9.5/65 - 15	COMPACTOR	40
16"	10.5/80 - 16	COMPACTOR	40
	11.00 - 20	COMPACTOR	40
	11.00 - 20	COMP. EXTRA	40
	11.00 - 20	COMP.SMOOTH	40
	11.00 R 20	COMPACTOR	40
24"	13/80 R 20	COMPACTOR	40
	13.00 - 24	TG-02	42
	14.00 - 24	TG-02	42
	14.9 - 24 IND	UK 5	42
	16.9 - 24 IND	UK 10	42
26"	23.1 - 26 IND	UK 5	42
	23.1 - 26 IND	UK 10	42
Crane Radial Tyres			
25"	335/95 R 25	CR-01	46
	445/95 R 25	CR-01	46
	445/95 R 25	CR-02	46
	525/80 R 25	CR-01	46
Multipurpose Radial Tyres			
18"	335/80 R 18 (12.5 R 18)	EM-02	50
20"	335/80 R 20 (12.5 R 20)	MPT-20	50
	335/80 R 20 (12.5 R 20)	MPT-21	50
	365/80 R 20 (14.5 R 20)	MPT-20	50
22.5"	365/80 R 20 (14.5 R 20)	MPT-21	50
	405/70 R 20 (16/70 R 20)	MPT-21	50
	275/90 R 22.5	SRT2	52
24"	375/75 R 22.5	MPT-23	52
	405/70 R 24 (16/70 R 24)	MPT-21	52
	445/70 R 24 (17.5L R 24)	MPT-22	52
Multipurpose Diagonal Tyres			
18"	12.5 - 18	MPT-03	56
20"	10.5 - 20	MPT-05	56
	10.5 - 20	MPT-07	56
	12.5 - 20	MPT-03	56
	12.5 - 20	MPT-05	56
	14.5 - 20	MPT-03	56
	14.5 - 20	MPT-05	56
	16/70 - 20 (405/70 - 20)	MPT-05	56
	405/70 - 20 (16/70 - 20)	MPT-03	56

Size (inch)	Tyre size (Alternative tyre size)	Tread pattern	Page
Tractor Industrial Radial Tyres			
18"	340/80 R 18 IND	TI-20	60
24"	460/70 R 24 IND (17.5L R 24)	TI-22	60
26"	480/80 R 26 IND	TI-20	60
28"	440/80 R 28 IND	TI-20	60
Construction Applications Diagonal Tyres			
18"	320/80 - 18 IND (12.5/80-18)	TR-09	64
	340/80 - 18 IND (12.5-18)	MPT-04	66
20"	280/80 - 20 IND (10.5-20)	MPT-04	66
	340/80 - 20 IND (12.5-20)	MPT-04	66
	360/85 - 20 IND (14.5-20)	MPT-04	66
	400/70 - 20 IND (16.0/70-20)	MPT-04	66
	400/75 - 20 IND (16.0/70-20)	TR-09	64
22.5"	480/65 - 22.5 IND (18-22.5)	MPT-06	66
24"	400/70 - 24 IND	MPT-04	66
	400/80 - 24 IND (15.5/80-24)	TI-05	68
	16.9 - 24 IND	TI-04	68
	16.9 - 24	TG-01	68
	17.5L - 24 IND	TI-02	68
	460/70 - 24 IND (17.5L-24)	TI-05	70
	19.5L - 24 IND	TI-05	70
	19.5L - 24 IND	GRIP-n-RIDE	70
	500/70 - 24 IND (19.5L-24)	TI-05	70
	21L - 24 IND	GRIP-n-RIDE	70
26"	18.4 - 26 IND	TI-06	70
28"	16.9 - 28 IND	TI-06	70
	16.9 - 28	TG-01	70
30"	440/80 - 30 IND (16.9-30)	TI-09	72
Skid Steer Diagonal Tyres			
12"	23×8.50 - 12	SK-02	76
15"	27×8.50 - 15	SK-02	76
	27×10.50 - 15	SK-02	76
	31×15.50 - 15	SK-02	76
15.3"	10.0/75 - 15.3	SK-01	76
16.5"	10 - 16.5	SK-02	78
	10 - 16.5	SK-05	78
	10 - 16.5	BIG BOY	78
	12 - 16.5	SK-02	78
	12 - 16.5	SK-05	78
	12 - 16.5	BIG BOY	78
17.5"	14 - 17.5 IND	TR-10	78
18"	10.5/80 - 18	BIG BOY	78
	12.5/80 - 18	BIG BOY	78

Size (inch)	Tyre size (Alternative tyre size)	Tread pattern	Page
Material Handling Diagonal Tyres			
8"	4.00 - 8	FL-03	86
	4.00 - 8	FL-08	82
	15×4.5 - 8	FL-08	82
	5.00 - 8	FL-03	86
	5.00 - 8	FL-08	82
	16×6 - 8 (150/75-8)	FL-08	82
	18×7 - 8 (180/70-8)	FL-08	82
9"	6.00 - 9	FL-08	82
	21×8 - 9 (200/75-9)	FL-08	82
10"	6.50 - 10	FL-08	82
	7.50 - 10	FL-08	82
	23×9 - 10 (225/75-10)	FL-08	82
12"	7.00 - 12	FL-08	82
	23×10 - 12	FL-08	82
	27×10 - 12 (250/75-12)	FL-08	82
13"	23 × 5	FL-07	86
15"	7.00 - 15	FL-08	82
	7.50 - 15	FL-08	82
	8.15 - 15 (28×9-15)	FL-08	82
	8.25 - 15	FL-08	82
	250 - 15 (250/70-15)	FL-08	82
	28×12.5 - 15	FL-08	82
	300 - 15 (315/70-15)	FL-08	82

Tyre size marking

440/70 R 24	
440	Nominal section width (in mm)
70	Aspect ratio H/SW (in %)
R	Radial construction
24	Nominal rim diameter (in inches)

16/70 - 20	
16	Nominal section width (in inches)
70	Aspect ratio H/SW (in %)
-	Cross-ply construction
20	Nominal rim diameter (in inches)

27×8.50 - 12	
27	Overall diameter (in inches)
8.5	Nominal section width (in inches)
-	Cross-ply construction
12	Nominal rim diameter (in inches)

17.5 L-24	
17.5	Nominal section width (in inches)
L	Reduced aspect ratio
-	Cross-ply construction
24	Nominal rim diameter (in inches)

12.5 - 18	
12.5	Nominal section width (in inches)
-	Cross-ply construction
18	Nominal rim diameter (in inches)

23×5	
23	Overall diameter (in inches)
5	Nominal section width (in inches)

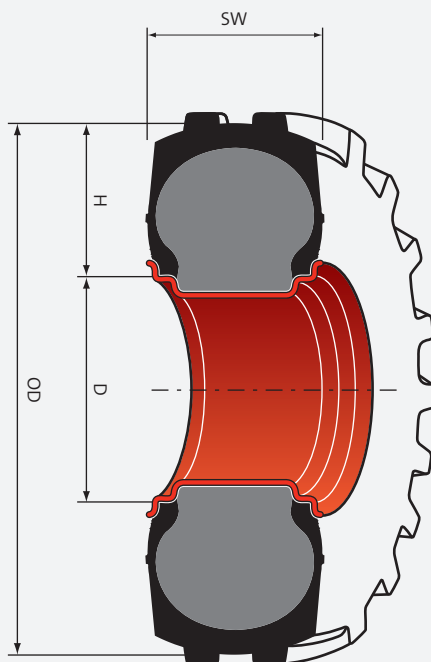

SW Section width
 OD Overall diameter
 H Section height
 D Rim diameter

Speed symbols and conversion tables

Speed category

Speed symbol	A1	A2	A3	A4	A5	A6	A7	A8	B	D	F	G	J	K
Speed (km/h)	5	10	15	20	25	30	35	40	50	65	80	90	100	110

Pressure units conversion table

bar	1.0	1.5	2.0	2.5	3.0	3.5	4.0	4.5	5.0	5.5
kPa	100	150	200	250	300	350	400	450	500	550
p.s.i.	15	22	29	36	44	51	58	65	73	80

bar	6.0	6.5	7.0	7.5	8.0	8.5	9.0	9.5	10.0	10.5
kPa	600	650	700	750	800	850	900	950	1 000	1 050
p.s.i.	87	94	102	109	116	123	131	138	145	152

Units conversion table

Length	Mass	Pressure
1 millimeter (mm) = 0.03937"	1 pound (lb) = 0.4536 kg	1 p.s.i. (lb/in ²) = 6.895 kPa
1 inch (") = 25.4 mm = 0.0254 m	1 kilogram (kg) = 2.205 lb	1 kg/cm ² = 98.066 kPa
1 meter (m) = 3.281 ft		1 bar = 100 kPa
1 foot (ft) = 0.3048 m	Volume	
1 kilometer (km) = 0.6214 mile	1 litre (l) = 0.21 gall	
1 mile = 1 609 m = 1.609 km	1 imperial gallon (imp.gal) = 4.55 l	

Tyre sidewall marking



Sign	Meaning
MITAS	Trademark of producer
440/70 R 24	Tyre size marking
17.5 LR 24	Alternative size marking
EM-02	Tread pattern code
147	Load index (LI 147 = 3 075 kg)
B	Speed symbol (B = 50 km/h)
164	Load index (LI 164 = 5 020 kg)
A2	Speed symbol (A2 = 10 km/h)
TUBELESS	Tubeless tyre
↔↔↔↔	Direction of rotation

Tyre structure



- Tread Pattern
- Sidewall
- Breaker Cord
- Apex
- Inner Liner
- Bead Wire
- Casing Cord



BIAS (DIAGONAL, CROSS-PLY) TYRE

A pneumatic tyre in which the ply cords extend to the beads and are laid substantially at alternate angles less than 90° to the centre-line of the tread.



RADIAL PLY TYRE

A pneumatic tyre in which the ply cords extend to the beads and are laid substantially at 90° to the centre-line of the tread, the carcass being stabilised by an essentially inextensible circumferential belt.

Load index

LI	kg	LI	kg	LI	kg	LI	kg	LI	kg
80	450	107	975	134	2 120	161	4 625	188	10 000
81	462	108	1 000	135	2 180	162	4 750	189	10 300
82	475	109	1 030	136	2 240	163	4 875	190	10 600
83	487	110	1 060	137	2 300	164	5 000	191	10 900
84	500	111	1 090	138	2 360	165	5 150	192	11 200
85	515	112	1 120	139	2 430	166	5 300	193	11 500
86	530	113	1 150	140	2 500	167	5 450	194	11 800
87	545	114	1 180	141	2 575	168	5 600	195	12 150
88	560	115	1 215	142	2 650	169	5 800	196	12 500
89	580	116	1 250	143	2 725	170	6 000	197	12 850
90	600	117	1 285	144	2 800	171	6 150	198	13 200
91	615	118	1 320	145	2 900	172	6 300	199	13 600
92	630	119	1 360	146	3 000	173	6 500	200	14 000
93	650	120	1 400	147	3 075	174	6 700	201	14 500
94	670	121	1 450	148	3 150	175	6 900	202	15 000
95	690	122	1 500	149	3 250	176	7 100	203	15 500
96	710	123	1 550	150	3 350	177	7 300	204	16 000
97	730	124	1 600	151	3 450	178	7 500	205	16 500
98	750	125	1 650	152	3 550	179	7 750	206	17 000
99	775	126	1 700	153	3 650	180	8 000	207	17 500
100	800	127	1 750	154	3 750	181	8 250	208	18 000
101	825	128	1 800	155	3 875	182	8 500	209	18 500
102	850	129	1 850	156	4 000	183	8 750	210	19 000
103	875	130	1 900	157	4 125	184	9 000		
104	900	131	1 950	158	4 250	185	9 250		
105	925	132	2 000	159	4 375	186	9 500		
106	950	133	2 060	160	4 500	187	9 750		



Universal application

EM-01

TRACTION	=====
SERVICE LIFE	=====
RESISTANCE	=====
RIDING COMFORT	=====
RETRADING	=====



Excellent traction

EM-02

TRACTION	=====
SERVICE LIFE	=====
RESISTANCE	=====
RIDING COMFORT	=====
RETRADING	=====

EM radial series

Ready to move the Earth

EM-01

Non-directional tread pattern for **all-round application**.

Suitable above all for front loaders, telescopic loaders, backhoe loaders, dumpers and similar vehicles for **light earthmoving work**.

All steel radial construction.

Tyre size	EM-01	EM-02
335/80 R 18 (12.5 R 18)		•
365/70 R 18	•	
405/70 R 18 (16/70 R 18)	•	
335/80 R 20 (12.5 R 20)	•	
365/80 R 20 (14.5 R 20)	•	
405/70 R 20 (16/70 R 20)	•	
405/70 R 24 (16/70 R 24)	•	
440/70 R 24 (17.5 L R 24)		•
500/70 R 24 IND	•	

EM-02

Tread pattern with **good traction** properties.

Excellent durability.

Suitable above all for backhoe loaders, wheeled loaders, telescopic handlers and similar vehicles for **light service**.

Also suitable for **agricultural application**.



EM radial series

Technical data and load capacities

Tyre size	Tread pattern Type	Rim (permitted)	New		Max. in service		Loaded static radius (mm)	Rolling circumference (mm)	Tread depth (mm)	
			Overall diameter (mm)	Section width (mm)	Overall diameter (mm)	Overall width (mm)				
335/80 R 18 (12.5 R 18)	EM-02 TL	11×18	993	339	1 025	354	448	2 990	25	
365/70 R 18	EM-01 TL	11×18 (12×18)	969	360	1 000	400	437	2 915	20	
405/70 R 18 (16/70 R 18)	EM-01 TL	13×18	1 025	407	1 070	452	462	3 085	20	
335/80 R 20 (12.5 R 20)	EM-01 TL	11×20 (12×20)	1 044	339	1 076	366	470	3 140	20	
365/80 R 20 (14.5 R 20)	EM-01 TL	11×20 (12×20)	1 092	360	1 127	400	489	3 285	20	
405/70 R 20 (16/70 R 20)	EM-01 TL	13×20 (11; 12×20)	1 076	407	1 121	452	487	3 240	20	



	Service description LI/SS Transport/ Loading	Tyre load capacity (kg) at speed (km/h)						Tyre pressure (bar)
		0	10	20	30	40	50	
139 B/151 A2		2 526	1 579	1 371	1 254	1 137	1 098	1.4
		3 347	2 092	1 817	1 661	1 505	1 451	2.0
		3 888	2 430	2 102	1 926	1 744	1 684	2.4
		4 659	2 912	2 544	2 319	2 110	2 025	3.0
		5 520	3 450	3 036	2 760	2 540	2 430	3.8
135 B/146 A2		2 395	1 515	1 221	1 177	1 140	1 110	1.5
		2 990	1 885	1 518	1 463	1 415	1 380	2.0
		3 440	2 135	1 689	1 627	1 570	1 535	2.5
		3 970	2 470	1 958	1 887	1 820	1 780	3.0
		4 505	2 795	2 222	2 141	2 070	2 020	3.5
		4 800	3 000	2 398	2 311	2 250	2 180	3.8
141 B/153 A2		2 745	1 705	1 315	1 267	1 240	1 195	1.5
		3 470	2 165	1 689	1 627	1 580	1 535	2.0
		4 170	2 590	2 019	1 945	1 890	1 835	2.5
		4 850	3 015	2 343	2 258	2 195	2 130	3.0
		5 520	3 430	2 651	2 555	2 490	2 410	3.5
		5 850	3 650	2 833	2 730	2 650	2 575	3.8
156 B/168 A2		5 935	3 710	2 893	2 788	2 715	2 630	4.0
		6 630	4 150	3 262	3 143	3 055	2 965	4.5
		7 265	4 550	3 575	3 445	3 355	3 250	5.0
		7 840	4 910	3 861	3 721	3 620	3 510	5.5
		8 355	5 225	4 081	3 933	3 830	3 710	6.0
		8 950	5 600	4 400	4 240	4 125	4 000	6.5
136 B/147 A2		2 370	1 485	1 188	1 145	1 110	1 080	1.5
		2 970	1 815	1 480	1 426	1 390	1 345	2.0
		3 540	2 210	1 766	1 701	1 650	1 605	2.5
		4 100	2 490	2 030	1 956	1 910	1 845	3.0
		4 650	2 880	2 321	2 237	2 170	2 110	3.5
	4 925	3 075	2 464	2 374	2 300	2 240	3.8	
141 B/153 A2		2 750	1 710	1 309	1 261	1 225	1 190	1.5
		3 470	2 185	1 683	1 622	1 575	1 530	2.0
		4 150	2 610	2 002	1 929	1 865	1 820	2.5
		4 840	3 030	2 338	2 253	2 195	2 125	3.0
		5 505	3 440	2 662	2 565	2 480	2 420	3.5
		5 850	3 650	2 833	2 730	2 650	2 575	3.8
143 B/155 A2		2 905	1 800	1 370	1 320	1 280	1 245	1.5
		3 705	2 325	1 771	1 707	1 650	1 610	2.0
		4 455	2 790	2 129	2 051	1 995	1 935	2.5
		5 165	3 230	2 470	2 380	2 295	2 245	3.0
		5 880	3 670	2 822	2 719	2 635	2 565	3.5
		6 200	3 875	2 998	2 889	2 800	2 725	3.8

EM radial series (continued)

Technical data and load capacities

Tyre size	Tread pattern Type	Rim (permitted)	New		Max. in service		Loaded static radius (mm)	Rolling circumference (mm)	Tread depth (mm)	
			Overall diameter (mm)	Section width (mm)	Overall diameter (mm)	Overall width (mm)				
405/70 R 24 (16/70 R 24)	EM-01 TL	13×24	1 178	407	1 223	452	534	3 545	20	
440/70 R 24 (17.5L R 24)	EM-02 TL	W 15 L×24	1 250	465	1 299	490	563	3 750	38	
500/70 R 24 IND	EM-01	DW16L×24 DW15L×24	1 310	503	1 338	528	585	3 945	28	



	Service description LI/SS Transport/ Loading	Tyre load capacity (kg) at speed (km/h)						Tyre pressure (bar)
		0	10	20	30	40	50	
146 B/158 A2		3 155	1 945	1 513	1 458	1 410	1 375	1.5
		3 985	2 470	1 909	1 839	1 790	1 735	2.0
		4 835	2 995	2 310	2 226	2 165	2 100	2.5
		5 630	3 500	2 717	2 618	2 535	2 470	3.0
		6 440	3 985	3 102	2 989	2 930	2 820	3.5
		6 800	4 250	3 300	3 180	3 100	3 000	3.8
147 B/164 A2		4 240	2 650	2 488	2 398	2 330	2 262	1.4
		6 480	4 050	2 728	2 629	2 700	2 480	2.0
		7 072	4 420	2 981	2 873	2 950	2 710	2.4
		7 776	4 860	3 267	3 148	3 240	2 970	3.0
		8 032	5 020	3 383	3 260	3 350	3 075	3.2
164 A8/164 B		4 500	2 930	2 750	2 560	2 360	2 360	1.6
		5 500	3 585	3 250	3 025	2 800	2 800	2.0
		6 500	4 240	3 740	3 490	3 240	3 240	2.4
		8 000	5 220	4 500	4 190	3 905	3 905	3.0
		9 500	6 200	5 200	4 885	4 560	4 560	3.6
		10 500	6 850	5 700	5 350	5 000	5 000	4.0



Excellent traction



EM-20 (NB 38) (L-2)

Tread pattern with excellent traction and self-cleaning properties. Tubeless tyre for construction machinery.



Longer service life



EM-30 (NB 57) (L-3)

Tread pattern with excellent durability and puncture resistance. Suitable for loaders in hard operating conditions.



Universal application



EM-60 (L-3)

Tread pattern designed mainly for heavy construction site machines and other machinery operating in combined conditions. Very good self-cleaning properties.



Excellent traction



EM-70 (E-2/L-2)

Tread pattern with good traction and minimal wheel slip, excellent cushioning, dumping and self-cleaning properties.



Excellent traction



EM-80 (L-2/G-2)

Excellent traction and self-cleaning performances. Suitable for telescopic handlers, graders and loaders.

EM diagonal series

Reliable tyres for demanding earthmoving work

Tyre size	EM-20	EM-30	EM-60	EM-70	EM-80
20-24 (22/70-24)				•	
15.5-25	•		•		•
17.5-25	•	•	•		
20.5-25	•	•	•		
23.5-25	•	•	•		
26.5-25		•	•		
26.5-29		•			
18.00-25	•				

Surface suitability chart – EM series

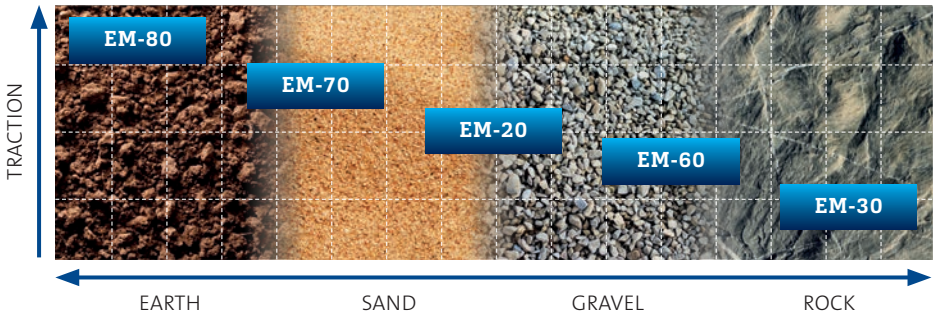

EM diagonal series

Technical data and load capacities

Tyre size	Tread pattern Type	Rim (permitted)	New		Max. in service		Loaded static radius (mm)	Rolling circumference (mm)	Tread width (mm)	Tread depth (mm)	
			Overall diameter (mm)	Section width (mm)	Overall diameter (mm)	Overall width (mm)					
20 - 24 (22/70 - 24)	EM-70 TL	16.00 T-24 SDC	1 390	545	1 452	585	633	4 170	460	28.5	
15.5 - 25	EM-20 TL	12.00/1.3-25 (13.00/1.4-25)	1 277	394	1 328	437	590	3 857	325	28	
	EM-60 TL	12.00/1.3-25 (13.00/1.4-25)	1 277	394	1 328	437	590	3 857	355	26	
15.5 - 25	EM-80 TL	12.00/1.3-25	1 277	394	1 328	437	550	3 777	352	25.4	
17.5 - 25	EM-20 TL	14.00/1.5-25	1 348	445	1 405	494	620	4 063	370	30	
	EM-30 TL	14.00/1.5-25	1 348	445	1 405	494	620	4 063	370	30	
	EM-60 TL	14.00/1.5-25	1 348	445	1 405	494	620	4 063	392	28	

Contact Mitas for information on other applications of L-2 and L-3 tyres than on wheel loaders, grades, telescopic handlers or dozers.



Tread pattern	Service description LI/SS Loader	Ply rating	Loader service Tyre load capacity (kg) at speed (km/h)			Tyre pressure (bar)
			Static	5	10	
EM-70	173 A2/158 B	12 PR	6 880	4 859	4 300	1.50
			7 520	5 311	4 700	1.75
			8 160	5 763	5 100	2.00
			8 720	6 159	5 450	2.25
			9 280	6 554	5 800	2.50
			9 840	6 950	6 150	2.75
			10 400	7 345	6 500	3.00
			6 800	4 803	4 250	2,50
EM-20 EM-60	168 A2/149 B	12 PR	7 160	5 057	4 475	2,75
			7 480	5 283	4 675	3,00
			7 800	5 509	4 875	3,25
			8 160	5 763	5 100	3,50
			8 560	6 046	5 350	3,75
			8 960	6 328	5 600	4,00
			6 800	4 803	4 250	2.50
			EM-80	174 A2/151 A8	16 PR	7 160
7 480	5 283	4 675				3.00
7 800	5 509	4 875				3.25
8 160	5 763	5 100				3.50
8 560	6 046	5 350				3.75
8 960	6 328	5 600				4.00
9 256	6 537	5 785				4.25
9 544	6 740	5 965				4.50
9 840	6 950	6 150				4.75
10 136	7 159	6 335				5.00
10 424	7 362	6 515				5.25
10 720	7 571	6 700				5.50
10 240	7 232	6 400				3.75
10 640	7 515	6 650				4.00
EM-20 EM-30 EM-60	177 A2/158 B	16 PR	11 040	7 797	6 900	4.25
			11 360	8 023	7 100	4.50
			11 680	8 249	7 300	4.75
			14 520	10 255	9 075	6.50
EM-20 EM-60	188 A2/171 B	22 PR	15 280	10 792	9 550	6.75
			16 000	11 300	10 000	7.00

EM diagonal series (continued)

Technical data and load capacities

Tyre size	Tread pattern Type	Rim (permitted)	New		Max. in service		Loaded static radius (mm)	Rolling circumference (mm)	Tread width (mm)	Tread depth (mm)	
			Overall diameter (mm)	Section width (mm)	Overall diameter (mm)	Overall width (mm)					
18.00 - 25	NB 38 TL	13.00/2.5-25 (15.00/2.5-25)	1 615	498	1 693	553	734	4 840	404	38	
20.5 - 25	EM-20 TL	17.00/2.0-25 (17.00/1.7-25)	1 492	520	1 561	577	682	4 484	450	38	
	EM-30 TL	17.00/2.0-25 (17.00/1.7-25)	1 492	520	1 561	577	682	4 484	450	38	
	EM-60 TL	17.00/2.0-25 (17.00/1.7-25)	1 492	520	1 561	577	682	4 484	470	32	
23.5 - 25	EM-20 TL	19.50/2.5-25	1 617	597	1 696	663	734	4 843	530	45	
	EM-30 TL	19.50/2.5-25	1 617	597	1 696	663	734	4 843	530	40	
	EM-60 TL	19.50/2.5-25	1 617	597	1 696	663	734	4 843	540	40	

Contact Mitas for information on other applications of L-2 and L-3 tyres than on wheel loaders, grades, telescopic handlers or dozers.

EM-20
(NB 38)



EM-30
(NB 57)



EM-60



Tread pattern	Service description LI/SS Loader	Ply rating	Loader service Tyre load capacity (kg) at speed (km/h)			Tyre pressure (bar)			
			Static	5	10				
NB 38	199 A2/180 B	28 PR	17 280	12 204	10 800	4.25			
			18 400	12 995	11 500	4.75			
			18 880	13 334	11 800	5.00			
			20 000	14 125	12 500	5.50			
			20 480	14 464	12 800	5.75			
			20 960	14 803	13 100	6.00			
			21 760	15 368	13 600	6.50			
EM-20 EM-30 EM-60	181 A2/167 B	16 PR	8 720	6 159	5 450	1.75			
			9 440	6 667	5 900	2.00			
			10 080	7 119	6 300	2.25			
			10 720	7 571	6 700	2.50			
			11 360	8 023	7 100	2.75			
			12 000	8 475	7 500	3.00			
			12 640	8 927	7 900	3.25			
			13 200	9 323	8 250	3.50			
			EM-60	186 A2/170 B	20 PR	13 760	9 718	8 600	3.75
						14 240	10 057	8 900	4.00
						14 720	10 396	9 200	4.25
15 200	10 735	9 500				4.50			
15 616	11 029	9 760				4.75			
16 032	11 323	10 020				5.00			
	189 A2/174 B	24 PR	16 480	11 639	10 300	5.25			
EM-20 EM-30 EM-60	191 A2/177 B	20 PR	12 800	9 040	8 000	2.25			
			13 600	9 605	8 500	2.50			
			14 400	10 170	9 000	2.75			
			15 200	10 735	9 500	3.00			
			16 000	11 300	10 000	3.25			
			16 800	11 865	10 500	3.50			
			17 440	12 317	10 900	3.75			
				199 A2/183 B	28 PR	19 600	13 843	12 250	5.00
			20 640			14 577	12 900	5.25	
			21 760			15 368	13 600	5.50	

EM diagonal series (continued)

Technical data and load capacities

Tyre size	Tread pattern Type	Rim (permitted)	New		Max. in service		Loaded static radius (mm)	Rolling circumference (mm)	Tread width (mm)	Tread depth (mm)
			Overall diameter (mm)	Section width (mm)	Overall diameter (mm)	Overall width (mm)				
26.5 - 25	EM-30 TL	22.00/3.0-25	1 750	673	1 839	747	791	5 231	605	45
	EM-60 TL	22.00/3.0-25	1 750	673	1 839	747	791	5 231	605	45
26.5 - 29	NB 57 TL	22.00/3.0-29 (24.00/3.0-29)	1 851	673	1 940	747	834	5 525	600	45

Contact Mitas for information on other applications of L-2 and L-3 tyres than on wheel loaders, grades, telescopic handlers or dozers.

Variation in load capacity with speed dependence

Speed (km/h)	0	1	5	10	15	20	25
Load capacity	+60 %	+30 %	+13 %	(0)	-7 %	-12 %	-15 %

EM-30
(NB 57)



EM-60



Tread pattern	Service description LI/SS Loader	Ply rating	Loader service Tyre load capacity (kg) at speed (km/h)			Tyre pressure (bar)
			Static	5	10	
EM-30 EM-60	203 A2/188 B	28 PR	20 320	14 351	12 700	3.25
			21 120	14 916	13 200	3.50
			21 760	15 368	13 600	3.75
			22 400	15 820	14 000	4.00
			23 200	16 385	14 500	4.25
			24 000	16 950	15 000	4.50
			24 800	17 515	15 500	4.75
			25 600	18 080	16 000	5.00
			26 400	18 645	16 500	5.25
			27 200	19 210	17 000	5.50
NB 57	204 A2/189 B	26 PR	23 200	16 385	14 500	3.75
			24 000	16 950	15 000	4.00
			24 800	17 515	15 500	4.25
			25 600	18 080	16 000	4.50

Dimensions of "O" rings (mm)

Tyre size	Inside diameter	Section diameter	Circumference
15.5 - 25 17.5 - 25	581±2	6.6±0.5	1 825±6
18.0 - 25 20.5 - 25 23.5 - 25 26.5 - 25	568±2	9.8±0.5	1 784±6
26.5 - 29	655±2	9.8±0.5	2 058±6



Excellent traction



Universal application



MPT-01

Tread pattern with very good traction and self-cleaning properties. Suitable above all for loader applications.



MPT-02

Universal tread pattern for various application with good traction and self-cleaning properties.



Universal application



Effective self-cleaning



MPT-03

Universal tread pattern for on- and off-road application with good traction. Suitable for municipal, on road service, agricultural and other special service vehicles.



MPT-04

Tread pattern with excellent treadwear and durability. Maximum traction capabilities in soft soil.



Enhanced lateral stability



Excellent traction



MPT-06

Tread pattern with excellent traction properties and enhanced stability. Especially suitable for telescopic handlers and excavators.



MPT-08

Robust tread pattern with good traction and perfect stability. Designed especially for excavators and telescopic handlers in hard terrain.

Light equipment diagonal tyres

Proven tread patterns for lighter machinery

Tyre size	MPT-01	MPT-02	MPT-03	MPT-04	MPT-06	MPT-08
280/80-18 (10.5-18)	•					
10.5-18		•				
340/80-18 (12.5-18)	•					
18-19.5		•	•		•	•
10.5-20				•		
340/80-20 (12.5-20)	•					
16/70-20 (405/70-20)		•				
405/70-20 (16/70-20)	•					
405/70-24 (16/70-24)	•					
405/70-24				•		



Light equipment series

Technical data and load capacities

Tyre size	Tread pattern Type	Rim (permitted)	Tube Flap	New		Max. in service		Loaded static radius (mm)	Rolling circumference (mm)	Tread depth (mm)
				Overall diameter (mm)	Section width (mm)	Overall diameter (mm)	Overall width (mm)			
280/80-18 (10.5-18)	MPT-01 TL	9×18	10-18	905	270	927	292	419	2 660	22
10.5-18	MPT-02 TL	9×18	10-18	905	270	927	292	419	2 660	20
340/80-18 (12.5-18)	MPT-01 TL	11×18 (9×18)	12.5-18 12-18HS	990	325	1 017	351	455	2 910	25
18-19.5	MPT-02 TL	14.00×19.5 (13.00×19.5)	—	1 080	457	1 121	494	490	3 140	30



MPT-01

MPT-02

Tread pattern	Service description LI/SS	Ply rating	Tyre load capacity (kg) at speed (km/h)								Tyre pressure (bar)	
			Static	10	20	30	40	50	60	65		
MPT-01	130 B		3 271	2 368	1 835	1 687	1 628	1 480			2.25	
			3 403	2 464	1 910	1 756	1 694	1 540			2.50	
			3 558	2 576	1 996	1 835	1 771	1 610			2.75	
			3 757	2 720	2 108	1 938	1 870	1 700			3.00	
			3 934	2 848	2 207	2 029	1 958	1 780			3.25	
			4 077	2 952	2 288	2 103	2 030	1 845			3.50	
		140 B		4 199	3 040	2 356	2 166	2 090	1 900			3.75
	4 530			3 280	2 540	2 330	2 250	2 050			4.50	
	4 860			3 520	2 720	2 500	2 420	2 200			5.00	
	5 190			3 760	2 910	2 670	2 580	2 350			5.50	
			5 525	4 000	3 100	2 850	2 750	2 500		6.00		
MPT-02	129 D	10 PR	3 525	2 327	1 833	1 622	1 495	1 466	1 424	1 410	2.25	
			3 700	2 442	1 924	1 702	1 569	1 539	1 495	1 480	2.50	
			3 900	2 574	2 028	1 794	1 654	1 622	1 576	1 560	2.75	
			4 125	2 723	2 145	1 898	1 749	1 716	1 667	1 650	3.00	
			4 250	2 805	2 210	1 955	1 802	1 768	1 717	1 700	3.25	
			4 450	2 937	2 314	2 047	1 887	1 851	1 798	1 780	3.50	
			4 625	3 053	2 405	2 128	1 961	1 924	1 869	1 850	3.75	
			3 337	2 416	1 872	1 721	1 661	1 510			1.75	
			3 602	2 608	2 021	1 858	1 793	1 630			2.00	
			3 845	2 784	2 158	1 984	1 914	1 740			2.25	
4 111	2 976	2 306	2 120	2 046	1 860			2.50				
4 287	3 104	2 406	2 212	2 134	1 940			2.75				
4 486	3 248	2 517	2 314	2 233	2 030			3.00				
MPT-01	132 B		4 652	3 368	2 610	2 400	2 316	2 105			3.25	
			4 818	3 488	2 703	2 485	2 398	2 180			3.50	
	145 B		5 350	3 875	3 000	2 760	2 660	2 420			4.00	
			5 875	4 255	3 300	3 030	2 925	2 660			4.50	
			6 410	4 640	3 595	3 300	3 190	2 900			5.00	
			6 133	4 440	3 441	3 164	3 053	2 775			2.75	
6 575	4 760	3 689	3 392	3 273	2 975			3.00				
6 962	5 040	3 906	3 591	3 465	3 150			3.25				
7 348	5 320	4 123	3 791	3 658	3 325			3.50				
7 735	5 600	4 340	3 990	3 850	3 500			3.75				
8 122	5 880	4 557	4 190	4 043	3 675			4.00				
8 509	6 160	4 774	4 389	4 235	3 850			4.25				
8 840	6 400	4 960	4 560	4 400	4 000			4.50				
MPT-02	156 B	16 PR	6 133	4 440	3 441	3 164	3 053	2 775			2.75	
			6 575	4 760	3 689	3 392	3 273	2 975			3.00	
			6 962	5 040	3 906	3 591	3 465	3 150			3.25	
			7 348	5 320	4 123	3 791	3 658	3 325			3.50	
			7 735	5 600	4 340	3 990	3 850	3 500			3.75	
			8 122	5 880	4 557	4 190	4 043	3 675			4.00	
			8 509	6 160	4 774	4 389	4 235	3 850			4.25	
			8 840	6 400	4 960	4 560	4 400	4 000			4.50	

Light equipment series (continued)

Technical data and load capacities

Tyre size	Tread pattern Type	Rim (permitted)	Tube Flap	New		Max. in service		Loaded static radius (mm)	Rolling circumference (mm)	Tread depth (mm)	
				Overall diameter (mm)	Section width (mm)	Overall diameter (mm)	Overall width (mm)				
18 - 19.5	MPT-03 TL	14.00×19.5 (13.00×19.5)	–	1 080	457	1 121	494	490	3 140	24	
18 - 19.5	MPT-06 TL	14.00×19.5 (13.00×19.5)	–	1 100	470	1 129	505	508	3 280	30	
	MPT-08 TL	14.00×19.5 (13.00×19.5)	–	1 100	470	1 129	505	508	3 280	33	
10.5 - 20	MPT-04 TL	9×20 (9-20SDC)	10.5-20	955	270	977	292	440	2 810	21	
340/80 - 20 (12.5 - 20)	MPT-01 TL	11×20 (11;12-20SDC)	–	1 040	325	1 067	351	480	3 060	25	
16/70 - 20 (405/70 - 20)	MPT-02 TL	13×20 (13-20SDC)	–	1 076	407	1 116	440	495	3 165	28	



	Tread pattern	Service description LI/SS	Ply rating	Tyre load capacity (kg) at speed (km/h)							Tyre pressure (bar)					
				Static	10	20	30	40	50	60		65				
	MPT-03	156 D	16 PR	6 383	4 579	3 608	3 191	2 942	2 886	2 803	2 775	2.75				
				6 843	4 909	3 868	3 421	3 154	3 094	3 005	2 975	3.00				
				7 245	5 198	4 095	3 623	3 339	3 276	3 182	3 150	3.25				
				7 648	5 486	4 323	3 824	3 525	3 458	3 358	3 325	3.50				
				8 050	5 775	4 550	4 025	3 710	3 640	3 535	3 500	3.75				
				8 453	6 064	4 778	4 226	3 896	3 822	3 712	3 675	4.00				
				8 855	6 353	5 005	4 428	4 081	4 004	3 889	3 850	4.25				
				9 200	6 600	5 200	4 600	4 240	4 160	4 040	4 000	4.50				
					MPT-06 MPT-08	160 A8	16 PR	3 720	3 120	2 784	2 640	2 400				1.75
								4 108	3 445	3 074	2 915	2 650				2.00
4 418	3 705	3 306	3 135					2 850				2.25				
4 728	3 965	3 538	3 355					3 050				2.50				
5 038	4 225	3 770	3 575					3 250				2.75				
5 348	4 485	4 002	3 795					3 450				3.00				
5 627	4 719	4 211	3 993					3 630				3.25				
5 890	4 940	4 408	4 180					3 800				3.50				
6 161	5 168	4 611	4 373					3 975				3.75				
6 433	5 395	4 814	4 565					4 150				4.00				
6 704	5 623	5 017	4 758	4 325				4.25								
6 975	5 850	5 220	4 950	4 500				4.50								
	MPT-06	166 A8	-	7 363	6 175	5 510	5 225	4 750				4.75				
				7 595	6 370	5 684	5 390	4 900				5.00				
				7 905	6 630	5 916	5 610	5 100				5.25				
				8 215	6 890	6 148	5 830	5 300				6.00				
	MPT-04	131 D	10 PR	3 312	2 376	1 872	1 656	1 526	1 498	1 454	1 440	2.25				
				3 496	2 508	1 976	1 748	1 611	1 581	1 535	1 520	2.50				
				3 680	2 640	2 080	1 840	1 696	1 664	1 616	1 600	2.75				
				3 864	2 772	2 184	1 932	1 781	1 747	1 697	1 680	3.00				
				4 071	2 921	2 301	2 036	1 876	1 841	1 788	1 770	3.25				
				4 278	3 069	2 418	2 139	1 972	1 934	1 879	1 860	3.50				
				4 485	3 218	2 535	2 243	2 067	2 028	1 970	1 950	3.75				
				4 442	3 216	2 492	2 291	2 211	2 010			2.75				
4 619	3 344	2 592	2 383	2 299	2 090			3.00								
	MPT-01	136 B		4 818	3 488	2 703	2 485	2 398	2 180			3.25				
				4 995	3 616	2 802	2 576	2 486	2 260			3.50				
	MPT-02	148 D	14 PR	5 359	3 845	3 029	2 680	2 470	2 423	2 353	2 330	2.25				
				5 739	4 117	3 244	2 869	2 645	2 595	2 520	2 495	2.50				
				6 486	4 653	3 666	3 243	2 989	2 933	2 848	2 820	3.00				
				6 866	4 925	3 881	3 433	3 164	3 104	3 015	2 985	3.25				
				7 245	5 198	4 095	3 623	3 339	3 276	3 182	3 150	3.50				

Light equipment series (continued)

Technical data and load capacities

Tyre size	Tread pattern Type	Rim (permitted)	Tube Flap	New		Max. in service		Loaded static radius (mm)	Rolling circumference (mm)	Tread depth (mm)
				Overall diameter (mm)	Section width (mm)	Overall diameter (mm)	Overall width (mm)			
405/70 - 20 (16/70-20)	MPT-01 TL	13×20 (13-20SDC)	–	1 076	407	1 116	440	495	3 165	35
405/70 - 24 (16/70-24)	MPT-01 TL	13×24 (13-24SDC)	16/70-24	1 178	407	1 218	440	545	3 465	35
405/70 - 24	MPT-04 TL	13×24 (13-24SDC)	16/70-24	1 178	407	1 218	440	545	3 465	30

Variation in load capacity with speed dependence

Speed (km/h)	0	10	20	30	40	50	60	65
Tyre speed category	A8	+55%	+30%	+16%	+10%	(0)	–	–
	B	+121%	+60%	+24%	+14%	+10%	(0)	–
	D	+130%	+65%	+30%	+15%	+6%	+4%	+1%



MPT-01

MPT-04

	Tread pattern	Service description LI/SS	Ply rating	Tyre load capacity (kg) at speed (km/h)								Tyre pressure (bar)
				Static	10	20	30	40	50	60	65	
MPT-01	149 B	14 PR	5 304	3 840	2 976	2 736	2 640	2 400			2.25	
			5 691	4 120	3 193	2 936	2 833	2 575			2.50	
			6 431	4 656	3 608	3 317	3 201	2 910			3.00	
	6 807		4 928	3 819	3 511	3 388	3 080			3.25		
	7 183		5 200	4 030	3 705	3 575	3 250			3.50		
	7 514		5 440	4 216	3 876	3 740	3 400			3.75		
152 B	16 PR	7 846	5 680	4 402	4 047	3 905	3 550			4.00		
		7 404	5 360	4 154	3 819	3 685	3 350			3.75		
MPT-01	152 B	14 PR	7 846	5 680	4 402	4 047	3 905	3 550			4.00	
MPT-04	152 B	14 PR	6 115	4 425	3 430	3 155	3 045	2 765			2.00	
			6 325	4 580	3 550	3 260	3 150	2 860			2.50	
			6 510	4 715	3 655	3 360	3 240	2 945			3.00	
			7 020	5 080	3 940	3 620	3 495	3 175			3.50	
			7 935	5 680	4 405	4 050	3 905	3 550			4.00	
			8 840	6 400	4 960	4 560	4 400	4 000			4.50	



Excellent traction



EM-22

New generation of tyre for excavators. Modified tread pattern NB 38, giving excellent traction and self-cleaning properties. Wider by about 7% in comparison with NB 38. Suitable above all for high power modern excavators.



Designed for rocky terrain



EM-23

Higher resistance to puncture and tread wear due to higher filling of tread area. Special tread pattern for stony and hard terrain.



Classic design



NB 38

Classic tread pattern profile for universal application with good traction and self-cleaning properties.



Excellent traction



NB 38 Extra ML

Wider tread area in comparison with NB 38 by about 23–25%. Better stability due to wider tread area.



Universal application



EX-01

Non-directional tread pattern for excavators. Reinforced sidewall especially designed for double mounting. **All steel radial construction.**



Excellent traction



TI-12

Tread pattern with excellent traction for flotation tyres, designed above all for powered wheels of agricultural and industrial machines. Applicable for trailed wheels as well.

Excavator tyres – wide range of patterns for various conditions

Tyre size	EM-22	EM-23	NB 38	NB 38 Extra ML	TI-12	EX-01
8.25-20			•	•		
9.00-20	•		•	•		
10.00-20	•	•	•	•		
11.00-20	•		•			
500/45-20					•	
315/80-22.5						•
500/60-22.5					•	
600/40-22.5					•	

Surface suitability chart – excavator tyres

	Crushed Rock	Gravel	Road	Sand	Loam	Mud
EM-23	■	■	■	■	■	■
EX-01	■	■	■	■	■	■
EM-22	■	■	■	■	■	■
NB 38	■	■	■	■	■	■
NB 38 Extra ML	■	■	■	■	■	■
TI-12	■	■	■	■	■	■

Variation in load capacity with speed dependence – TI-12

500/45-20, 500/60-22.5, 600/40-22.5

Speed (km/h)	0	10	15	20	25	30	35	40	45	50
Load capacity	+65%	+40%	+33%	+26%	+19%	+12%	+5%	(0)	-5%	-10%



Excavator

Technical data and load capacities

Tyre size	Tread pattern Type	Rim (permitted)	Tube Flap	New		Max. in service		Load- ed static radius (mm)	Rolling circum- ference (mm)	Tread width (mm)	
				Overall diameter (mm)	Section width (mm)	Overall diameter (mm)	Overall width (mm)				
8.25 - 20	NB 38 TT	6.5 - 20 (6.0;7.0 - 20)	8.25 - 20 20/1 eHD	970	234	993	253	462	2 940	185	
	NB 38 Extra ML TT	6.5 - 20 (6.0;7.0 - 20)	8.25 - 20 20/1 eHD	970	234	993	253	462	2 940	220	
9.00 - 20	NB 38 TT	7.0 - 20 (6.5;7.5 - 20)	9.00 - 20 20/1 eHD	1 012	256	1 037	276	481	3 070	190	
	NB 38 Extra ML TT	7.0 - 20 (6.5;7.5 - 20)	9.00 - 20 20/1 eHD	1 012	256	1 037	276	481	3 070	234	
	EM-22 TT	7.0 - 20 (6.5;7.5 - 20)	9.00 - 20 20/1 eHD	1 012	256	1 037	276	481	3 070	203	
10.00 - 20	NB 38 TT	7.5 - 20 (7.0;8.0 - 20)	10.00 - 20 20/2 eHD	1 050	275	1 077	297	498	3 180	215	
	NB 38 Extra ML TT	7.5 - 20 (7.0;8.0 - 20)	10.00 - 20 20/2 eHD	1 050	275	1 077	297	498	3 180	264	
	EM-22	7.5 - 20 (7.0;8.0 - 20)	10.00 - 20 20/2 eHD	1 050	275	1 077	297	498	3 180	230	
	EM-23	7.5 - 20 (7.0;8.0 - 20)	10.00 - 20 20/2 eHD	1 050	275	1 077	297	498	3 180	230	
11.00 - 20	NB 38 TT	8.0 - 20 (7.5 - 20)	11.00 - 20 20/2 eHD	1 080	291	1 109	314	511	3 275	240	
	EM-22 TT	8.0 - 20 (7.5 - 20)	11.00 - 20 20/2 eHD	1 080	291	1 109	314	511	3 275	254	
500/45 - 20	TI-12 TL	16.00×20DC	–	980	490	1 030	530	445	2 910	–	
315/80 R 22.5#	EX-01 TL	9.00×22.5	–	1 103	325	1 130	345	506	3 400	300	
500/60 - 22.5	TI-12 TL	16.00×22.5DC	–	1 192	503	1 234	543	519	3 504	–	
600/40 - 22.5	TI-12 TL	20.00×22.5DC	–	1 050	600	1 107	642	473	3 146	–	

In preparation, please contact Mitas for availability.



	Tread depth (mm)	Minimal dual spacing (mm)	Tread pattern	Service description LI/SS	Ply rating	Tyre load capacity (kg) at speed (km/h)					Tyre pressure (bar)				
						Static	10	20	30	40		50			
	18	269	NB 38 NB 38 Extra ML	122 B	14 PR	2 825	2 260	1 885	1 542	1 457	1 415	6.00			
	18	269				2 910	2 330	1 940	1 586	1 499	1 455	6.50			
	20	297	NB 38 NB 38 Extra ML EM-22	140 B	14 PR	4 710	3 770	3 200	2 572	2 431	2 360	6.50			
	20	297				4 850	3 880	3 300	2 649	2 503	2 430	6.75			
	20	297				5 000	4 000	3 400	2 725	2 575	2 500	7.00			
	20	316	NB 38 Extra ML	145 B	14 PR	6 380	4 595	3 830	3 117	2 946	2 860	6.00			
	22	316	NB 38 NB 38 Extra ML EM-22 EM-23	146 B	16 PR	6 575	4 735	3 945	3 210	3 033	2 945	6.50			
	20	316				6 790	4 850	3 880	3 172	2 997	2 910	7.25			
	18	316				7 000	5 000	4 000	3 270	3 090	3 000	7.50			
	25	335	NB 38 EM-22	148 B	16 PR	6 750	4 900	4 042	3 278	3 098	3 008	6.50			
	25	335				6 990	5 050	4 180	3 390	3 203	3 110	7.00			
						7 200	5 200	4 300	3 488	3 296	3 200	7.25			
	32	–	TI-12	160 A8	–	6 831	5 795	5 215	4 640	4 140	3 725	5.20			
						7 128	6 050	5 440	4 840	4 320	3 890	5.60			
						7 425	6 300	5 670	5 040	4 500	4 050	6.00			
	23	–	EX-01	154 A8	–	7 770	4 630	4 170	3 700	3 310	2 980	7.50			
						8 290	4 940	4 440	3 950	3 530	3 170	8.00			
						8 810	5 250	4 730	4 200	3 750	3 380	8.50			
	35	–	TI-12	152 A8	–	5 264	4 466	4 019	3 573	3 190	2 871	2.80			
						5 478	4 648	4 183	3 718	3 320	2 988	3.00			
						5 693	4 830	4 347	3 864	3 450	3 105	3.20			
						5 858	4 970	4 473	3 976	3 550	3 195	3.60			
	35	–	TI-12	169 A8	–	3 201	2 715	2 445	2 175	1 940	1 745	1.20			
						3 597	3 050	2 745	2 440	2 180	1 960	1.50			
						3 993	3 390	3 050	2 710	2 420	2 180	1.80			
						4 373	3 710	3 340	2 970	2 650	2 385	2.10			
						4 496	3 815	3 435	3 050	2 725	2 455	2.20			
						4 868	4 130	3 715	3 305	2 950	2 655	2.50			
						5 198	4 410	3 970	3 530	3 150	2 835	2.80			
						8 085	6 860	6 175	5 490	4 900	4 410	4.50			
						8 399	7 125	6 415	5 700	5 090	4 580	4.80			
						8 696	7 380	6 640	5 900	5 270	4 745	5.10			
						8 993	7 630	6 865	6 105	5 450	4 905	5.40			
						9 290	7 880	7 095	6 305	5 630	5 065	5.70			
									9 570	8 120	7 310	6 495	5 800	5 220	6.00



Effective self-cleaning



COMPACTOR (C-1)

Special tyre for rollers. The same tread pattern for Compactor, Compactor Extra and Compactor Smooth.



TG-02 (R-4)

Tread pattern with good traction and self-cleaning properties.



Directional stability



UK 5 (R-3)

Tread pattern suitable for industrial and road construction equipment.



Directional stability



UK 10 (R-3)

Tread pattern suitable for industrial and road construction equipment.

Roller & Tractor Grader tyres

Road works specialists

Tyre size	COMP.	TG-02	UK 5	UK 10
9.5/65 - 15	•			
10.5/80 - 16	•			
11.00 - 20	•			
11.00 R 20	•			
13/80 R 20	•			
13.00 - 24		•		
14.00 - 24		•		
14.9 - 24 IND			•	
16.9 - 24 IND				•
23.1 - 26 IND			•	•



Roller & Tractor Grader

Technical data and load capacities

Tyre size	Tread pattern Type	Rim (permitted)	Tube Flap	New		Max. in service		Loaded static radius (mm)	Rolling circumference (mm)	Minimal dual spacing (mm)
				Overall diameter (mm)	Section width (mm)	Overall diameter (mm)	Overall width (mm)			
9.5/65 - 15	COMPACTOR TL	15 × 7 JA	–	671	243	685	263	333	2 019	280
10.5/80 - 16	COMPACTOR TL	16 × 8 LB	–	812	285	830	307	372	2 430	330
11.00 - 20	COMPACTOR TT	8.0-20 (7.5-20)	11.00-20 20/2 eHD	1 040	290	1 062	314	493	3 150	335
11.00 - 20	COMPACTOR EXTRA TT	8.0-20 (8.5-20)	11.00-20 20/2 eHD	1 064	294	1 086	314	504	3 225	340
11.00 - 20	COMPACTOR SMOOTH TT	8.0-20 (8.5-20)	11.00-20 20/2 eHD	1 070	291	1 092	314	507	3 240	335
11.00 R 20*	COMPACTOR TT	8.0-20	11.00-20 20/2 eHD	1 069	293	1 097	316	–	3 210	352
13/80 R 20*	COMPACTOR TT	9.0-20	13/80-20	1 050	322	1 072	348	–	3 150	387

* All steel radial construction



COMPACTOR

Service description LI/SS	Ply rating	Tyre load capacity (kg) at speed (km/h)						Tyre pressure (bar)
		Static	5	8	10	15	25	
	6 PR	1 700 1 970 2 100	1 200 1 400 1 500		1 060 1 230 1 315			2.50 3.00 3.25
	6 PR	2 160 2 600 3 000	1 540 1 850 2 140		1 350 1 620 1 875			2.00 2.50 3.00
164 A3	16 PR			1 400 2 020 2 640 3 240 3 800 4 350 4 900 5 480 6 000		1 350 1 900 2 480 3 000 3 500 4 000 4 500 5 000		2.00 3.00 4.00 5.00 6.00 7.00 8.00 9.00 10.00
170 A2	18 PR	7 984 8 272 8 488 8 712 9 000 9 216 9 600			4 990 5 170 5 305 5 445 5 625 5 760 6 000			6.25 6.55 6.90 7.25 7.60 8.00 8.30
156 A5	18 PR	6 109 6 311 6 468 6 624 7 360			3 818 3 945 4 042 4 140 4 600		3 320 3 430 3 515 3 600 4 000	7.25 7.60 8.00 8.30 10.00
157 A3	—				1 500 1 900 2 250 2 625 2 950 3 300 3 925 4 550 5 150	1 200 1 525 1 800 2 100 2 375 2 625 3 150 3 650 4 125		1.50 2.00 2.50 3.00 3.50 4.00 5.00 6.00 7.00
164 A3	—				2 520 3 100 3 660 4 260 4 840 5 420 5 710 6 000	2 240 2 760 3 260 3 790 4 310 4 820 5 000		3.00 4.00 5.00 6.00 7.00 8.00 8.50 9.00

Roller & Tractor Grader (continued)

Technical data and load capacities

Tyre size	Tread pattern Type	Rim (permitted)	Tube Flap	New		Max. in service		Loaded static radius (mm)	Rolling circumference (mm)	Tread depth (mm)
				Overall diameter (mm)	Section width (mm)	Overall diameter (mm)	Overall width (mm)			
13.00-24	TG-02 TT/TL	8.00TG SDC (9.00/1.5 (DC))	13.00-24	1 278	333	1 318	360	579	3 770	25
14.00-24	TG-02 TT/TL	8.00TG SDC (10.00 VA SDC)	14.00-24	1 348	362	1 392	391	608	3 975	25

Tyre size	Tread pattern Type	Rim (permitted)	New		Max. in service		Loaded static radius (mm)	Rolling circumference (mm)	Tread depth (mm)
			Overall diameter (mm)	Section width (mm)	Overall diameter (mm)	Overall width (mm)			
14.9-24 IND	UK 5 TL	W 13×24	1 250	395	1 285	425	580	3 710	18
16.9-24 IND	UK 10 TL	W 15 L×24	1 308	442	1 335	464	579	3 729	22
23.1-26 IND	UK 5 TL	DW 20 A×26	1 580	587	1 635	634	750	4 660	20
	UK 10 TL	DW 20 A×26	1 580	587	1 635	634	750	4 660	30



	Service description LI/SS	Ply rating	Tyre load capacity (kg) at speed (km/h)					Tyre pressure (bar)
			5	10	15	25	40	
143 A8	12 PR	12 PR	3 502	3 090	2 760	2 287	2 060	2.00
			4 012	3 540	3 162	2 620	2 360	2.50
			4 633	4 088	3 652	3 025	2 725	3.00
153 A8	16 PR	16 PR	5 049	4 455	3 980	3 297	2 970	3.25
			5 653	4 988	4 456	3 691	3 325	3.50
			6 205	5 475	4 891	4 052	3 650	3.75

	Tread pattern	Service description LI/SS	Ply rating	Tyre load capacity (kg) at speed (km/h)							Tyre pressure (bar)
				Static	10	10 cyclic	20	30	40	50	
UK 5	128 A8	8 PR	8 PR	3 265	1 775	2 130	1 935	1 477	1 420	1 292	1.20
				3 565	1 938	2 325	2 112	1 612	1 550	1 411	1.40
				3 865	2 100	2 520	2 289	1 747	1 680	1 529	1.60
				4 140	2 250	2 700	2 453	1 872	1 800	1 638	1.80
UK 10	129 B	8 PR	8 PR	4 140	2 250	2 700	2 160	1 925	1 800	1 640	1.30
				4 395	2 390	2 865	2 350	2 045	1 910	1 738	1.50
				4 635	2 520	3 024	2 480	2 155	2 016	1 850	1.70
UK 5	158 A8	10 PR	10 PR	7 865	4 275	5 130	3 730	3 555	3 420	3 110	1.20
				8 625	4 690	5 625	4 090	3 900	3 750	3 415	1.40
				9 405	5 115	6 135	4 460	4 255	4 090	3 720	1.60
				9 775	5 315	6 375	4 635	4 420	4 250	3 870	1.70
UK 5 UK 10	162 A8	12 PR	12 PR	10 925	5 940	7 125	5 180	4 940	4 750	4 325	1.90



CR-01

TRACTION	=====
SERVICE LIFE	=====
RESISTANCE	=====
SPEED	=====
COMFORT	=====



CR-02

TRACTION	=====
SERVICE LIFE	=====
RESISTANCE	=====
SPEED	=====
COMFORT	=====

CR-01 and CR-02 – new generation of crane tyre for improved productivity

CR-01 – Open tread block design for excellent traction and easy self-cleaning in off-road application. Deepest tread pattern in category.

CR-02 – High operating economy on the road thanks lower rolling resistance.

Better performance due to high maximum **speed up to 85 km/h**.

Reduced fuel consumption thanks to all-steel construction improving rolling resistance.

Improved operator comfort and **low noise emissions** in road high speed service.

Regroovable and suitable for retreading thanks to high durability of carcass.

Homologated as M+S and meets requirements for **winter conditions**.

Fully homologated according to EU Directives 92/93, 2001/43 and 2005/11 (noise homologation).



CR series

Technical data and load capacities

Tyre size	Tread pattern Type	Rim (permitted)	New		Max. in service		Loaded static radius (mm)	Rolling circumference (mm)	Tread depth (mm)	
			Overall diameter (mm)	Section width (mm)	Overall diameter (mm)	Overall width (mm)				
385/95 R 25	CR-01 TL	9.50/1.7 CR-25 (10.00/1.5-25)	1 369	379	1 415	409	633	4 295	23	
445/95 R 25	CR-01 TL	11.00/1.7CR-25 (11.25/2.0-25) (11.00/1.7CR×25)	1 480	440	1 570	483	688	4 504	26	
	CR-02 TL	11.00/1.7CR-25 (11.25/2.0-25) (11.00/1.7CR×25)	1 473	440	1 549	475	686	4 506	23	
525/80 R 25	CR-01 TL	17.00/1.7CR-25 (17.00/2.0-25)	1 475	530	1 542	588	679	4 450	28	

Dimensions of “O” rings (mm)

Tyre size	Inside diameter	Section diameter	Circumference
385/95 R 25	568 ± 2	9.8 ± 0.5	1 784 ± 6
445/95 R 25			
525/80 R 25			



CR-01

CR-02

	Service description LI/SS	Tyre load capacity (kg) at speed (km/h)											Tyre pressure (bar)	
		Static	5	10	20	30	40	50	60	70	80	85		90
170 F		9 750	8 190	7 175	5 850	4 875	4 485	4 370	4 290	4 095	3 900			5.0
		11 250	9 450	8 280	6 750	5 625	5 175	5 040	4 950	4 725	4 500			6.0
		12 500	10 500	9 200	7 500	6 250	5 750	5 600	5 500	5 250	5 000			7.0
		13 750	11 550	10 120	8 250	6 875	6 325	6 160	6 050	5 775	5 500			8.0
		15 000	12 600	11 040	9 000	7 500	6 900	6 720	6 600	6 300	6 000			9.0
174 F		10 395	8 780	7 575	6 360	5 320	4 900	4 775	4 685	4 475	4 260	4 135		5.0
		12 125	10 255	8 855	7 430	6 215	5 720	5 570	5 470	5 220	4 970	4 820		6.0
		13 590	11 465	9 885	8 280	6 915	6 365	6 195	6 075	5 805	5 525	5 360		7.0
		15 160	12 795	11 035	9 255	7 740	7 125	6 940	6 815	6 510	6 195	6 010		8.0
		16 750	14 070	12 060	10 050	8 375	7 705	7 505	7 370	7 035	6 700	6 500		9.0
176 F		13 400	11 250	9 100	8 400	6 700	6 150	6 000	5 900	5 650	5 350		5 050	5.0
		15 400	12 950	10 500	9 250	7 700	7 100	6 900	6 800	6 500	6 150		5 800	6.0
		17 750	14 950	12 100	10 650	8 900	8 200	8 000	7 850	7 500	7 100		6 700	7.0



Longer service life



MPT-20



Universal perennial tread pattern.
On- and off- road application.
Municipal, military and other special vehicles.



Universal application



MPT-21

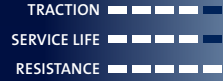

Non-directional tread pattern.
Good traction on- and off-the-road.
Effective self-cleaning properties.



Excellent traction



MPT-22 / EM-02



Good traction properties.
Excellent durability.
Also suitable for agricultural application.



Longer service life



MPT-23



Tread pattern for road application.
Low noise emission.
Excellent service life.



Rail and road application



SRT2



Rail & Road application.
Excellent durability.
Longer service life.

Multipurpose radial tyres

Universal tyres for on- and off-road use

Tyre size	MPT-20	MPT-21	MPT-22	MPT-23	EM-02	SRT2
335/80 R 18 (12.5 R 18)					•	
335/80 R 20 (12.5 R 20)	•	•				
365/80 R 20 (14.5 R 20)	•	•				
405/70 R 20 (16/70 R 20)		•				
275/90 R 22.5						•
375/75 R 22.5				•		
405/70 R 24 (16/70 R 24)		•				
445/70 R 24 (17.5 L R 24)			•			



MPT radial series

Technical data and load capacities

Tyre size	Tread pattern Type	Rim (permitted)	New		Max. in service		Loaded static radius (mm)	Rolling circumference (mm)	Tread depth (mm)	
			Overall diameter (mm)	Section width (mm)	Overall diameter (mm)	Overall width (mm)				
335/80 R 18 (12.5 R 18)	EM-02 TL	11×18 (12×18)	993	340	1 025	354	448	2 979	22	
335/80 R 20 (12.5 R 20)	MPT-20 TL	11×20 (12×20)	1 044	340	1 076	354	480	3 132	17.5	
335/80 R 20 (12.5 R 20)	MPT-21 TL	11×20 (12×20)	1 044	340	1 076	354	474	3 132	20	
365/80 R 20 (14.5 R 20)	MPT-20 TL	11×20 (12×20)	1 092	367	1 128	374	495	3 318	19	
365/80 R 20 (14.5 R 20)	MPT-21 TL	11×20 (12×20)	1 092	360	1 128	374	493	3 276	20	
405/70 R 20 (16/70 R 20)	MPT-21 TL	13×20 (12×20)	1 076	407	1 110	423	492	3 228	20	



EM-02

MPT-20

MPT-21

	Service description LI/SS	Tyre load capacity (kg) at speed (km/h)									Tyre pressure (bar)
		Static	10	40	50	70	80	90	100	110	
132G		1 913	1 185	890	850	800	795	765			1.00
		2 738	1 690	1 260	1 205	1 140	1 120	1 095			1.60
		3 250	2 045	1 490	1 440	1 375	1 340	1 300			2.00
		3 763	2 370	1 715	1 670	1 595	1 550	1 505			2.40
		4 463	2 840	2 040	2 000	1 905	1 840	1 785			3.00
		5 000	3 190	2 300	2 240	2 140	2 080	2 000			3.50
147 K		3 300	2 376	1 518	1 478	1 412	1 373	1 346	1 320	1 320	2.00
		4 500	3 240	2 070	2 016	1 926	1 872	1 836	1 800	1 800	3.00
		5 600	4 032	2 576	2 509	2 397	2 330	2 285	2 240	2 240	4.00
		6 563	4 725	3 019	2 940	2 809	2 730	2 678	2 625	2 625	5.00
		7 438	5 355	3 421	3 332	3 183	3 094	3 035	2 975	2 975	6.00
		8 688	5 535	3 536	3 444	3 290	3 198	3 137	3 075	3 075	6.50
139 J		2 430	1 515	1 155	1 142	1 080	1 055	1 030	1 020		1.50
		3 060	1 845	1 445	1 417	1 345	1 313	1 280	1 265		2.00
		3 650	2 260	1 715	1 691	1 600	1 565	1 530	1 510		2.50
		4 215	2 555	1 985	1 943	1 845	1 800	1 755	1 735		3.00
		4 835	3 015	2 300	2 262	2 160	2 103	2 045	2 020		3.50
		5 340	3 330	2 545	2 503	2 380	2 325	2 270	2 235		4.00
	5 850	3 650	2 790	2 722	2 600	2 540	2 480	2 430		4.50	
152 K		3 613	2 510	1 662	1 618	1 546	1 503	1 474	1 395	1 395	2.00
		5 000	3 485	2 300	2 240	2 140	2 080	2 040	2 000	2 000	3.00
		6 438	4 420	2 961	2 884	2 755	2 678	2 627	2 575	2 575	4.00
		7 500	5 375	3 450	3 360	3 210	3 120	3 060	2 970	2 970	5.00
		8 625	6 240	3 968	3 864	3 692	3 588	3 519	3 450	3 450	6.00
		8 875	6 390	4 083	3 976	3 799	3 692	3 621	3 550	3 550	6.25
152 J		2 800	1 745	1 260	1 238	1 185	1 158	1 130	1 105		1.50
		3 525	2 225	1 620	1 607	1 520	1 488	1 455	1 435		2.00
		4 875	3 090	2 255	2 223	2 100	2 058	2 015	1 985		3.00
		6 150	3 790	2 725	2 654	2 530	2 470	2 410	2 370		4.00
		7 450	4 595	3 325	3 265	3 095	3 023	2 950	2 915		5.00
		8 650	5 400	3 930	3 836	3 660	3 573	3 485	3 425		6.00
	8 950	5 600	4 080	3 976	3 800	3 710	3 620	3 550		6.25	
152J		2 780	1 765	1 270	1 249	1 175	1 153	1 130	1 115		1.50
		4 270	2 740	1 980	1 943	1 830	1 798	1 765	1 735		2.50
		5 635	3 600	2 620	2 559	2 430	2 385	2 340	2 285		3.50
		7 030	4 505	3 305	3 254	3 070	3 013	2 955	2 905		4.50
		8 210	5 240	3 815	3 730	3 530	3 465	3 400	3 330		5.50
		8 950	5 600	4 080	3 976	3 800	3 710	3 620	3 550		6.00

MPT radial series (continued)

Technical data and load capacities

Tyre size	Tread pattern Type	Rim (permitted)	New		Max. in service		Loaded static radius (mm)	Rolling circumference (mm)	Tread depth (mm)	
			Overall diameter (mm)	Section width (mm)	Overall diameter (mm)	Overall width (mm)				
275/90 R 22.5	SRT2 TL	8.25×22.5	1 076	270	1 100	286	491	3 261	17	
375/75 R 22.5	MPT-23 TL	11.75×22.5	1 140	380	1 163	394	521	3 582	25	
405/70 R 24 (16/70 R 24)	MPT-21 TL	13.0×24 (13×24)	1 178	407	1 212	423	538	3 534	20	
445/70 R 24 (17.5 L R 24)	MPT-22 TL	DW 15 L×24	1 255	465	1 292	471	573	3 765	38	



MPT-21

MPT-22

MPT-23

SRT2

Service description LI/SS	Tyre load capacity (kg) at speed (km/h)										Tyre pressure (bar)
	Static	10	40	50	70	80	90	100	110		
153 G/163 A5	6 235	4 570	2 895	2 825	2 670	2 595	2 495			5,50	
	6 710	4 905	3 100	3 040	2 875	2 790	2 685			6,00	
	7 185	5 240	3 310	3 250	3 075	2 990	2 875			6,50	
	7 625	5 590	4 165	3 460	3 200	3 170	3 050			7,00	
	8 075	5 935	3 760	3 675	3 455	3 360	3 230			7,50	
	8 600	6 250	3 980	3 880	3 680	3 580	3 440			8,00	
	9 125	6 570	4 195	4 085	3 905	3 795	3 650			8,50	
	165G	5 600	4 030	2 575	2 510	2 400	2 330	2 240			3,00
7 635		5 495	3 510	3 420	3 270	3 175	3 055			4,00	
8 785		6 325	4 040	3 935	3 760	3 655	3 515			5,00	
10 425		7 505	4 795	4 670	4 460	4 335	4 170			6,00	
11 460		8 250	5 270	5 135	4 905	4 765	4 585			7,00	
12 875		9 270	5 920	5 765	5 510	5 355	5 150			8,00	
152 J	3 225	1 990	1 435	1 378	1 270	1 258	1 245	1 230		1,50	
	4 085	2 525	1 820	1 753	1 670	1 628	1 585	1 565		2,00	
	4 920	3 035	2 200	2 106	2 020	1 967	1 915	1 880		2,50	
	5 750	3 535	2 575	2 486	2 370	2 313	2 255	2 220		3,00	
	6 545	4 065	2 940	2 845	2 715	2 650	2 585	2 540		3,50	
	7 390	4 555	3 315	3 209	3 055	2 980	2 905	2 865		4,00	
	8 165	5 055	3 675	3 573	3 390	3 310	3 230	3 190		4,50	
	8 950	5 600	4 080	3 976	3 800	3 710	3 620	3 550		5,00	
151G	3 000	2 150	1 380	1 344	1 284	1 248	1 200			1,00	
	4 825	3 470	2 220	2 162	2 065	2 007	1 930			2,00	
	6 625	4 770	3 050	2 968	2 836	2 756	2 650			3,00	
	7 525	5 430	3 470	3 371	3 221	3 130	3 010			3,50	
	8 450	6 080	3 880	3 786	3 617	3 515	3 380			4,00	
	8 625	6 210	3 970	3 864	3 692	3 588	3 450			4,10	



Universal application



MPT-03

Universal tread pattern for on- and off-road application with good traction. Suitable for municipal, on road service, agricultural and other special service vehicles.



Road application



MPT-05

Universal heavy-duty tread pattern for on- and off-road application. Suitable mainly for municipal, military, on road service and other special service vehicles.



Universal application



MPT-07

Non-directional tread pattern, suitable for various special service vehicles.

Multipurpose diagonal

Proven tread patterns
for wide range of application

Tyre size	MPT-03	MPT-05	MPT-07
12.5-18	•		
18-19.5	•		
10.5-20		•	•
12.5-20	•	•	
14.5-20	•	•	
16/70-20		•	
405/70-20	•		



MPT diagonal series

Technical data and load capacities

Tyre size	Tread pattern Type	Rim (permitted)	Tube Flap	New		Max. in service		Loaded static radius (mm)	Rolling circumference (mm)	Tread depth (mm)
				Overall diameter (mm)	Section width (mm)	Overall diameter (mm)	Overall width (mm)			
12.5 - 18	MPT-03 TL	11×18 (9×18)	12.5 - 18 12 - 18 HS	990	325	1 017	351	455	2 910	20
10.5 - 20	MPT-05 TL	9×20 (9-20 SDC)	10.5 - 20	955	270	977	292	440	2 810	16
	MPT-07 TT	9×20 (9-20 SDC)	10.5 - 20	955	270	977	292	440	2 810	18
12.5 - 20	MPT-03 TL	11×20 (11; 12-20 SDC)	–	1 040	325	1 067	351	480	3 060	20
12.5 - 20	MPT-05 TL	11×20 (11; 12-20 SDC)	12.5 - 20 (11 - 20)	1 040	325	1 067	351	480	3 060	18
14.5 - 20	MPT-03 TL	11×20 (11; 12-20 SDC)	14.5 - 20 (12.5 - 20)	1 095	355	1 124	383	503	3 220	24
	MPT-05 TL	11×20 (11; 12-20 SDC)	14.5 - 20 (12.5 - 20)	1 095	355	1 124	383	503	3 220	20
16/70 - 20 (405/70 - 20)	MPT-05 TL	13×20 (13-20 SDC)	16 - 20	1 076	407	1 116	440	495	3 165	22
405/70 - 20 (16/70 - 20)	MPT-03 TL	13×20 (13-20 SDC)	–	1 076	407	1 116	440	495	3 165	30

Variation in load capacity with speed dependence

Speed (km/h)	0	10	20	30	40	50	60	65	70	80	90
Load capacity	+150%	+80%	+50%	+25%	+15%	+12%	+10%	+8.5%	+7%	+4%	(0)



MPT-03 MPT-05 MPT-07

	Tread pattern	Service description L/SS	Ply rating	Tyre load capacity (kg) at speed (km/h)											Tyre pressure (bar)
				Static	10	20	30	40	50	60	65	70	80	90	
MPT-03	128 G	10 PR	3 387	2 439	2 032	1 694	1 558	1 517	1 490	1 470	1 450	1 409	1 355	1.75	
			3 618	2 605	2 171	1 809	1 664	1 621	1 592	1 570	1 548	1 505	1 447	2.00	
			3 871	2 787	2 323	1 935	1 781	1 734	1 703	1 680	1 657	1 610	1 548	2.25	
			4 124	2 970	2 475	2 062	1 897	1 848	1 815	1 790	1 765	1 716	1 650	2.50	
			4 332	3 119	2 599	2 166	1 993	1 941	1 906	1 880	1 854	1 802	1 733	2.75	
	4 500	3 240	2 700	2 250	2 070	2 016	1 980	1 950	1 926	1 872	1 800	3.00			
	4 700	3 384	2 820	2 350	2 162	2 106	2 068	2 040	2 012	1 955	1 880	3.25			
	4 875	3 510	2 925	2 438	2 243	2 184	2 145	2 120	2 087	2 028	1 950	3.50			
	136 G	16 PR	5 055	3 640	3 033	2 528	2 325	2 265	2 224	2 194	2 164	2 103	2 022	3.75	
			5 238	3 771	3 143	2 619	2 409	2 346	2 305	2 273	2 242	2 179	2 095	4.00	
5 420			3 902	3 252	2 710	2 493	2 428	2 385	2 352	2 320	2 255	2 168	4.25		
5 600			4 032	3 360	2 800	2 576	2 509	2 464	2 430	2 397	2 330	2 240	4.50		
3 325			2 394	1 995	1 663	1 530	1 490	1 463	1 443	1 423	1 383	1 330	2.25		
MPT-05 MPT-07	128 G	10 PR	3 500	2 520	2 100	1 750	1 610	1 568	1 540	1 519	1 498	1 456	1 400	2.50	
			3 688	2 655	2 213	1 844	1 696	1 652	1 623	1 600	1 578	1 534	1 475	2.75	
			3 875	2 790	2 325	1 938	1 783	1 736	1 705	1 682	1 659	1 612	1 550	3.00	
			4 088	2 943	2 453	2 044	1 880	1 831	1 799	1 774	1 749	1 700	1 635	3.25	
			4 288	3 087	2 573	2 144	1 972	1 921	1 887	1 861	1 835	1 784	1 715	3.50	
	4 500	3 240	2 700	2 250	2 070	2 016	1 980	1 953	1 926	1 872	1 800	3.75			
	4 750	3 420	2 850	2 375	2 185	2 128	2 090	2 062	2 033	1 976	1 900	3.25			
	5 000	3 600	3 000	2 500	2 300	2 240	2 200	2 170	2 140	2 080	2 000	3.50			
	132 G	12 PR	4 513	3 249	2 708	2 256	2 076	2 022	1 986	1 958	1 931	1 877	1 805	3.00	
			4 750	3 420	2 850	2 375	2 185	2 128	2 090	2 062	2 033	1 976	1 900	3.25	
5 000			3 600	3 000	2 500	2 300	2 240	2 200	2 170	2 140	2 080	2 000	3.50		
4 088			2 943	2 453	2 044	1 880	1 831	1 799	1 774	1 749	1 700	1 635	3.25		
4 375			3 150	2 625	2 188	2 013	1 960	1 925	1 899	1 873	1 820	1 750	2.00		
MPT-03 MPT-05	136 G	12 PR	4 700	3 384	2 820	2 350	2 162	2 106	2 068	2 040	2 012	1 955	1 880	2.25	
			5 000	3 600	3 000	2 500	2 300	2 240	2 200	2 170	2 140	2 080	2 000	2.50	
			5 300	3 816	3 180	2 650	2 438	2 374	2 332	2 300	2 268	2 205	2 120	2.75	
			5 600	4 032	3 360	2 800	2 576	2 509	2 464	2 430	2 397	2 330	2 240	3.00	
			6 550	4 716	3 930	3 275	3 013	2 934	2 882	2 843	2 803	2 725	2 620	3.00	
	145 G	14 PR	6 888	4 959	4 133	3 444	3 168	3 086	3 031	2 989	2 948	2 865	2 755	3.25	
			7 250	5 220	4 350	3 625	3 335	3 248	3 190	3 147	3 103	3 016	2 900	3.50	
			6 550	4 716	3 930	3 275	3 013	2 934	2 882	2 843	2 803	2 725	2 620	3.00	
			6 888	4 959	4 133	3 444	3 168	3 086	3 031	2 989	2 948	2 865	2 755	3.25	
			7 250	5 220	4 350	3 625	3 335	3 248	3 190	3 147	3 103	3 016	2 900	3.50	
MPT-03	145 G	14 PR	6 550	4 716	3 930	3 275	3 013	2 934	2 882	2 843	2 803	2 725	2 620	3.00	
			6 888	4 959	4 133	3 444	3 168	3 086	3 031	2 989	2 948	2 865	2 755	3.25	
			7 250	5 220	4 350	3 625	3 335	3 248	3 190	3 147	3 103	3 016	2 900	3.50	
			6 550	4 716	3 930	3 275	3 013	2 934	2 882	2 843	2 803	2 725	2 620	3.00	
			6 888	4 959	4 133	3 444	3 168	3 086	3 031	2 989	2 948	2 865	2 755	3.25	

Multipurpose Tyres

TI series – universal radial tyres for industrial and agricultural application

TI-20

New generation of tread pattern.

Suitable for construction, road and agricultural work.

Priority to traction.

Designed for muddy conditions.

Very good resistance to damage.

TI-22

Good traction and effective self-cleaning properties.

Excellent durability.

Suitable for backhoe loaders, wheeled loaders, telescopic handlers and similar vehicles for light service.

Also suitable for agricultural application.

Tyre size	TI-20	TI-22
340/80 R 18	•	
460/70 R 24 IND (17.5L R 24)		•
480/80 R 26 IND	•	
440/80 R 28 IND	•	



TI radial series

Technical data and load capacities

Tyre size	Tread pattern Type	Rim (permitted)	New		Max. in service		Loaded static radius (mm)	Rolling circumference (mm)	Tread depth (mm)	
			Overall diameter (mm)	Section width (mm)	Overall diameter (mm)	Overall width (mm)				
340/80 R 18 IND	TI-20 TL	11×18 (12×18, W 10×18, W 11×18)	1 001	343	1 023	360	449	2 993	30	
460/70 R 24 IND (17.5L R 24)	TI-22 TL	DW 14 L×24 (DW 15 L, DW 16 L, 14, 16, W 14 L)	1 254	455	1 280	478	559	3 700	38	
480/80 R 26 IND	TI-20 TL	DW 15 L×26 (DW 16 L×26)	1 428	500	1 458	525	640	4 250	34	
440/80 R 28 IND	TI-20 TL	DW 14 L×28 (DW 15 L×28)	1 415	441	1 445	466	640	4 235	34	

Variation in load capacity with speed dependence

Speed (km/h)	0	5	10	15	20	25	30	35	40	45	50
Constant load	+ 130%	+ 45%	+ 25%	+ 13%	+ 9%	+ 6%	+ 4%	+ 2%	(0)	- 4%	- 9%
Cyclic application	+ 130%	+ 67%*	+ 50%**	+ 34%	+ 23%	+ 11%	+ 7%	+ 3%	(0)	- 4%	- 9%

* One way distance 150 m.

** One way distance 600 m.



	Service description LI/SS	Tyre load capacity (kg) at speed (km/h)							Tyre pressure (bar)
		0	10	10 cyclic	20	30	40	50	
143 A8		3 760	2 045	2 450	1 780	1 700	1 635	1 570	2.0
		4 390	2 390	2 865	2 080	1 985	1 910	1 740	2.5
		5 015	2 725	3 270	2 375	2 270	2 180	1 985	3.0
		5 635	3 060	3 675	2 670	2 550	2 450	2 230	3.5
		6 265	3 405	4 090	2 970	2 835	2 725	2 480	4.0
159 A8		6 010	3 265	3 920	2 845	2 715	2 610	2 375	2.0
		7 020	3 815	4 580	3 330	3 175	3 055	2 780	2.5
		8 035	4 365	5 240	3 805	3 635	3 495	3 180	3.0
		9 050	4 920	5 900	4 290	4 090	3 935	3 580	3.5
		10 065	5 470	6 565	4 770	4 550	4 375	3 980	4.0
160 A8		7 073	3 844	4 613	3 352	3 198	3 075	2 798	2.0
		7 705	4 188	5 025	3 652	3 484	3 350	3 049	2.2
		8 165	4 438	5 325	3 870	3 692	3 550	3 231	2.4
		8 625	4 688	5 625	4 088	3 900	3 750	3 413	2.6
		9 200	5 000	6 000	4 360	4 160	4 000	3 640	2.8
		9 775	5 313	6 375	4 633	4 420	4 250	3 868	3.0
		10 350	5 625	6 750	4 905	4 680	4 500	4 095	3.2
156 A8		6 440	3 500	4 200	3 052	2 912	2 800	2 548	2.0
		6 900	3 750	4 500	3 270	3 120	3 000	2 730	2.2
		7 245	3 938	4 725	3 434	3 276	3 150	2 867	2.4
		7 935	4 313	5 175	3 761	3 588	3 450	3 140	2.6
		8 395	4 563	5 475	3 979	3 796	3 650	3 322	2.8
		8 913	4 844	5 813	4 224	4 030	3 875	3 526	3.0
		9 200	5 000	6 000	4 360	4 160	4 000	3 640	3.2



TI-02 (R-4)

Classic version of tread pattern for industrial use.



Excellent traction



TI-05 (R-4)

Robust industrial tread pattern with excellent traction properties.



Excellent traction



TI-09 (R-4)

Tread pattern with very good traction and self-cleaning properties.



TG-01 (R-4)

Robust industrial pattern with higher resistance to puncture and tread wear.



TI-04 (R-4)



Designed for 4x4

Industrial tread pattern for use on backhoe loaders with 4x4 axles.



Longer service life



TI-06 (R-4)

Robust industrial pattern with higher resistance to puncture and tread wear.



Excellent traction



GRIP 'N' RIDE (R-4)

Tread pattern suitable for backhoe loaders and other types of loaders with excellent self-cleaning properties and reinforced sidewall.



Effective self-cleaning



MPT-04

Tread pattern with excellent treadwear and durability. Maximum traction capabilities in soft soil.

Construction applications diagonal

Robust and durable tyres for construction and road works



Enhanced lateral stability

MPT-06



Tread pattern with excellent traction properties and enhanced stability. Especially suitable for telescopic handlers and excavators.

TR-09 (R-4)



Tread pattern with good traction.

Tyre size	TI-02	TI-04	TI-05	TI-06	TI-09	G'n'R	TG-01	MPT-04	MPT-06	TR-09
320/80 - 18 (12.5/80 - 18)										•
340/80 - 18 (12.5 - 18)								•		
280/80 - 20 (10.5 - 20)								•		
340/80 - 20 (12.5 - 20)								•		
360/85 - 20 (14.5 - 20)								•		
400/70 - 20 (16.0/70 - 20)								•		
400/75 - 20 (16.0/70 - 20)										•
480/65 - 22.5 (18 - 22.5)									•	
400/70 - 24								•		
400/80 - 24 (15.5/80 - 24)				•						
16.9 - 24		•					•			
17.5L - 24	•									
460/70 - 24 (17.5L - 24)			•							
19.5L - 24			•			•				
500/70 - 24 (19.5L - 24)			•							
21L - 24						•				
18.4 - 26				•						
16.9 - 28				•			•			
440/80 - 30 (16.9 - 30)					•					

Construction Applications Diagonal Tyres

Technical data and load capacities

Tyre size	Tread pattern Type	Rim (permitted)	New		Max. in service		Loaded static radius (mm)	Rolling circumference (mm)	Tread depth (mm)
			Overall diameter (mm)	Section width (mm)	Overall diameter (mm)	Overall width (mm)			
320/80 - 18 IND (12.5/80 - 18)	TR-09 TL	11×18 (9×18)	987	308	1 014	323	465	2 900	25
400/75 - 20 IND (16.0/70 - 20)	TR-09 TL	13 SDC - 20	1 095	408	1 125	450	504	3 220	27

Variation in load capacity with speed dependence – front tyres

Speed (km/h)		0	10	15	20	25	30	35	40	45	50
Free rolling (40 km/h)	LLV	+ 65%	+ 40%	+ 33%	+ 26%	+ 19%	+ 12%	+ 5%	(0)	- 5%	- 10%
	HLV	+ 98%	+ 68%	+ 60%	+ 51%	+ 43%	+ 34%	+ 26%	+ 20%	+ 14%	+ 8%
Drive wheels (40 km/h)	LLV	+ 135%	+ 40%	+ 33%	+ 26%	+ 19%	+ 12%	+ 5%	(0)	- 5%	- 10%
	HLV	+ 193%	+ 100%	+ 90%	+ 80%	+ 70%	+ 60%	+ 50%	+ 43%	+ 36%	+ 29%

LLV = Low Load Variation

HLV = High Load Variation, is where the tyre load varies by a factor of 2 or more between loaded and unloaded conditions. The inflation pressure for HLV application must be increased, consult tyre manufacturer. In the case of HLV, the maximum distance should not exceed 1 km. For a longer distance, consult tyre manufacturer.

TR-09



Service description LI/SS	Ply rating	Tyre load capacity (kg) – free rolling / drive wheels – at speed (km/h)					Tyre pressure (bar)
		10	20	30	40	50	
138/125 A8	12 PR	2 675/1 890	2 405/1 700	2 140/1 510	1 910/1 350	1 720/1 215	2.50
		2 865/2 015	2 575/1 815	2 290/1 615	2 045/1 440	1 840/1 295	2.80
		3 050/2 170	2 745/1 955	2 440/1 735	2 180/1 550	1 960/1 395	3.10
		3 200/2 235	2 880/2 010	2 560/1 790	2 285/1 595	2 055/1 435	3.40
		3 305/2 310	2 975/2 080	2 650/1 850	2 360/1 650	2 125/1 485	3.70
150/138 A8	14 PR	3 430/2 460	3 090/2 210	2 745/1 965	2 450/1 755	2 205/1 580	2.00
		3 815/2 730	3 435/2 455	3 050/2 185	2 725/1 950	2 450/1 755	2.50
		4 100/3 005	3 690/2 700	3 280/2 400	2 930/2 145	2 640/1 930	3.00
		4 690/3 305	4 220/2 975	3 750/2 645	3 350/2 360	3 015/2 125	3.50

Construction Applications Diagonal Tyres (continued)

Technical data and load capacities

Tyre size	Tread pattern Type	Rim (permitted)	Tube Flap	New		Max. in service		Loaded static radius (mm)	Rolling circumference (mm)	Tread depth (mm)
				Overall diameter (mm)	Section width (mm)	Overall diameter (mm)	Overall width (mm)			
340/80-18 IND (12.5-18)	MPT-04 TL	11×18 (9×18)	12.5-18 12-18 HS	990	325	1 017	351	455	2 910	25
280/80-20 IND (10.5-20)	MPT-04 TL	9×20 (9-20SDC)	10.5-20	955	270	977	292	440	2 940	21
340/80-20 IND (12.5-20)	MPT-04 TL	11×20 (11;12-20SDC)	12.5-20 (11-20)	1 040	325	1 067	351	480	3 060	22
360/85-20 IND (14.5-20)	MPT-04 TL	11×20 (11;12-20SDC)	14.5-20 (12.5-20)	1 095	355	1 124	383	503	3 220	25
400/70-20 IND (16.0/70-20)	MPT-04 TL	13×20 (13-20SDC)	–	1 076	407	1 116	440	495	3 165	26
480/65-22.5 IND (18-22.5)	MPT-06 TL	14.00×22.5	–	1 166	460	1 197	494	542	3 480	26



MPT-04

MPT-06

	Tread pattern	Service description L/SS	Ply rating	Tyre load capacity (kg) at speed (km/h)							Tyre pressure (bar)
				Static	10	20	30	40	50	60	
MPT-04	131 D	10 PR	3 381	2 426	1 911	1 691	1 558	1 529	1 485	1 470	1.75
			3 611	2 591	2 041	1 806	1 664	1 633	1 586	1 570	2.00
			3 864	2 772	2 184	1 932	1 781	1 747	1 697	1 680	2.25
	134 D	12 PR	4 117	2 954	2 327	2 059	1 897	1 862	1 808	1 790	2.50
			4 324	3 102	2 444	2 162	1 993	1 955	1 899	1 880	2.75
			4 485	3 218	2 535	2 243	2 067	2 028	1 970	1 950	3.00
	144 D	16 PR	4 692	3 366	2 652	2 346	2 162	2 122	2 060	2 040	3.25
			4 876	3 498	2 756	2 438	2 247	2 205	2 141	2 120	3.50
			6 072	4 356	3 432	3 036	2 798	2 746	2 666	2 640	4.50
MPT-04	133 A8/ 131 D	10 PR	6 325	4 538	3 575	3 163	2 915	2 860	2 778	2 750	4.75
			6 440	4 620	3 640	3 220	2 968	2 912	2 828	2 800	5.00
			3 310	2 375	1 870	1 655	1 525	1 500	1 455	1 440	2.25
	132 D	10 PR	3 495	2 510	1 975	1 750	1 610	1 580	1 535	1 520	2.50
			3 680	2 640	2 080	1 840	1 695	1 665	1 615	1 600	2.75
			3 865	2 770	2 185	1 930	1 780	1 750	1 695	1 680	3.00
	135 D	12 PR	4 070	2 920	2 300	2 035	1 875	1 840	1 790	1 770	3.25
			4 280	3 070	2 420	2 140	1 970	1 935	1 880	1 860	3.50
			4 485	3 220	2 535	2 245	2 065	2 030	1 970	1 950	3.75
MPT-04	132 D	10 PR	4 439	3 185	2 509	2 220	2 046	2 007	1 949	1 930	2.75
			4 600	3 300	2 600	2 300	2 120	2 080	2 020	2 000	3.00
			4 807	3 449	2 717	2 404	2 215	2 174	2 111	2 090	3.25
MPT-04	139 D	12 PR	5 014	3 597	2 834	2 507	2 311	2 267	2 202	2 180	3.50
			4 669	3 350	2 639	2 335	2 152	2 111	2 050	2 030	2.25
			4 991	3 581	2 821	2 496	2 300	2 257	2 192	2 170	2.50
MPT-04	142 D	14 PR	5 290	3 795	2 990	2 645	2 438	2 392	2 323	2 300	2.75
			5 589	4 010	3 159	2 795	2 576	2 527	2 454	2 430	3.00
			5 842	4 191	3 302	2 921	2 692	2 642	2 565	2 540	3.25
MPT-04	148 D	14 PR	6 095	4 373	3 445	3 048	2 809	2 756	2 677	2 650	3.50
			5 359	3 845	3 029	2 680	2 470	2 423	2 353	2 330	2.25
			5 739	4 117	3 244	2 869	2 645	2 595	2 520	2 495	2.50
MPT-06	163 A8	16 PR	6 486	4 653	3 666	3 243	2 989	2 933	2 848	2 820	3.00
			6 866	4 925	3 881	3 433	3 164	3 104	3 015	2 985	3.25
			7 245	5 198	4 095	3 623	3 339	3 276	3 182	3 150	3.50
			4 108	3 445	3 074	2 915	2 650				1.75
			4 495	3 770	3 364	3 190	2 900				2.00
			4 844	4 063	3 625	3 438	3 125				2.25
			5 193	4 355	3 886	3 685	3 350				2.50
			5 503	4 615	4 118	3 905	3 550				2.75
			5 813	4 875	4 350	4 125	3 750				3.00
			6 123	5 135	4 582	4 345	3 950				3.25
			6 433	5 395	4 814	4 565	4 150				3.50
			6 704	5 623	5 017	4 758	4 325				3.75
			6 975	5 850	5 220	4 950	4 500				4.00
			7 246	6 078	5 423	5 143	4 675				4.25
			7 518	6 305	5 626	5 335	4 850				4.50

Tractor Industrial Tyres

Construction Applications Diagonal Tyres (continued)

Technical data and load capacities

Tyre size	Tread pattern Type	Rim (permitted)	Tube Flap	New		Max. in service		Loaded static radius (mm)	Rolling circumference (mm)	Tread depth (mm)
				Overall diameter (mm)	Section width (mm)	Overall diameter (mm)	Overall width (mm)			
400/70-24 IND	MPT-04 TL	13 × 24 (13-24SDC)	16/70-24	1 178	407	1 218	440	545	3 465	30

Tyre size	Tread pattern Type	Rim (permitted)	New		Max. in service		Loaded static radius (mm)	Rolling circumference (mm)	Tread depth (mm)
			Overall diameter (mm)	Section width (mm)	Overall diameter (mm)	Overall width (mm)			
400/80-24 IND (15.5/80-24)	TI-05 TL	DW13 × 24 (DW14L × 24) (13 × 24, 14 × 24) (TW14L × 24)	1 250	404	1 294	436	573	3 688	35
16.9-24 IND	TI-04 TL	W15L × 24 (W14L × 24)	1 310	429	1 355	463	610	3 865	27
16.9-24	TG-01 TL	W15L × 24 (W14L × 24)	1 310	429	1 355	463	579	3 798	25
17.5L-24 IND	TI-02 TL	W15L × 24 (W14L × 24)	1 241	445	1 278	481	580	3 660	28



Tread pattern	Service description L/SS	Ply rating	Tyre load capacity (kg) at speed (km/h)								Tyre pressure (bar)
			Static	10	20	30	40	50	60	65	
MPT-04	151 D	14 PR	6 118	4 389	3 458	3 059	2 820	2 766	2 687	2 660	2.00
			6 325	4 538	3 575	3 163	2 915	2 860	2 778	2 750	2.50
			6 509	4 670	3 679	3 255	3 000	2 943	2 858	2 830	3.00
			7 015	5 033	3 965	3 508	3 233	3 172	3 081	3 050	3.50
			7 935	5 693	4 485	3 968	3 657	3 588	3 485	3 450	4.00
	156 B	-	6 325	4 580	3 550	3 260	3 150	2 860			2.50
			6 510	4 715	3 655	3 360	3 240	2 945			3.00
			7 020	5 080	3 940	3 620	3 495	3 175			3.50
			7 935	5 745	4 455	4 095	3 950	3 590			4.00
			8 840	6 400	4 960	4 560	4 400	4 000			4.50

Tread pattern	Service description L/SS	Ply rating	Tyre load capacity (kg) at speed (km/h)								Tyre pressure (bar)
			Static	10	10 cyclic	20	30	40	50		
TI-05	162 A8	-	5 975	3 245	3 895	2 830	2 700	2 595	2 365	2.00	
			6 800	3 695	4 435	3 220	3 075	2 956	2 690	2.50	
			7 625	4 145	4 975	3 615	3 450	3 315	3 020	3.00	
			8 450	4 590	5 510	4 005	3 820	3 675	3 340	3.50	
			9 275	5 040	6 050	4 395	4 195	4 030	3 670	4.00	
			10 100	5 490	6 585	4 785	4 565	4 390	3 995	4.50	
			10 925	5 940	7 125	5 180	4 940	4 750	4 325	5.00	
TI-04	149 A8	12 PR	3 795	2 065	2 475	1 800	1 715	1 650	1 500	1.00	
			4 335	2 355	2 830	2 055	1 960	1 885	1 715	1.20	
			4 875	2 650	3 180	2 310	2 205	2 120	1 930	1.40	
			5 395	2 930	3 520	2 555	2 440	2 345	2 135	1.60	
			5 865	3 190	3 825	2 780	2 650	2 550	2 320	1.80	
			6 360	3 455	4 150	3 015	2 875	2 765	2 515	2.00	
			6 900	3 750	4 500	3 270	3 120	3 000	2 730	2.20	
7 190	3 905	4 690	3 405	3 250	3 125	2 845	2.40				
7 475	4 065	4 875	3 545	3 380	3 250	2 960	2.60				
TG-01	149 A6	12 PR	6 590	3 580	4 295	3 120	2 980	2 865	2 605	2.30	
			6 785	3 685	4 425	3 215	3 070	2 950	2 685	2.40	
			6 980	3 795	4 555	3 310	3 160	3 035	2 760	2.50	
			7 185	3 905	4 685	3 405	3 250	3 125	2 840	2.60	
TI-02	144 A8	10 PR	4 195	2 500	3 000	2 250	2 000	1 785	1 605	1.10	
			4 700	2 800	3 360	2 520	2 240	2 000	1 800	1.30	
			5 205	3 100	3 720	2 790	2 480	2 215	1 995	1.50	
			5 711	3 400	4 080	3 060	2 720	2 430	2 185	1.70	
			6 216	3 705	4 446	3 335	2 960	2 645	2 380	2.00	
			6 580	3 920	4 704	3 530	3 135	2 800	2 520	2.20	

Construction Applications Diagonal Tyres (continued)

Technical data and load capacities

Tyre size	Tread pattern Type	Rim (permitted)	New		Max. in service		Loaded static radius (mm)	Rolling circumference (mm)	Tread depth (mm)
			Overall diameter (mm)	Section width (mm)	Overall diameter (mm)	Overall width (mm)			
460/70-24 IND (17.5L-24)	TI-05 TL	DW14L×24 (DW15L, DW16L, 14, 16, TW14L)	1 250	455	1 300	494	580	3 660	35
19.5L-24 IND	TI-05 TL	DW16L×24	1 314	495	1 356	535	610	3 865	32
	GRIP-n-RIDE TL	W16L×24 (DW16L×24)	1 314	495	1 356	535	610	3 865	27
500/70-24 IND (19.5L-24)	TI-05 TL	DW16L×24 (DW15L×24) (W15L×24) (W16L×24) (16×24)	1 310	503	1 360	528	589	3 865	32
21L-24 IND	GRIP-n-RIDE TL	DW18L×24	1 390	523	1 424	576	613	4 128	30
18.4-26 IND	TI-06 TL	W16L×26 (W15L×26)	1 425	467	1 470	504	665	4 190	29
16.9-28 IND	TI-06 TL	W15L×28 (W14L×28)	1 410	429	1 455	463	660	4 160	28
16.9-28	TG-01 TL	W15L×28 (W14L×28)	1 410	429	1 455	463	640	4 190	25



	Tread pattern	Service description L/SS	Ply rating	Tyre load capacity (kg) at speed (km/h)							Tyre pressure (bar)
				Static	10	10 cyclic	20	30	40	50	
	TI-05	159 A8	-	6 555	3 565	4 275	3 105	2 965	2 850	2 595	2.00
7 430				4 040	4 845	3 520	3 360	3 230	2 940	2.50	
8 305				4 515	5 415	3 935	3 755	3 610	3 285	3.00	
9 175				4 990	5 985	4 350	4 150	3 990	3 630	3.50	
10 065				5 470	6 565	4 770	4 550	4 375	3 980	4.00	
	TI-05 GRIP-n-RIDE	151 A8	12 PR	4 510	2 450	2 940	2 140	2 040	1 960	1 785	1.10
5 095				2 770	3 325	2 415	2 305	2 215	2 015	1.30	
5 680				3 090	3 705	2 690	2 570	2 470	2 250	1.50	
6 270				3 405	4 090	2 970	2 835	2 725	2 480	1.70	
7 075				3 845	4 615	3 350	3 200	3 075	2 800	1.90	
7 510	4 080	4 900	3 560	3 395	3 265	2 970	2.10				
7 935	4 315	5 175	3 760	3 590	3 450	3 140	2.30				
	TI-05	164 A8	-	7 705	4 185	5 022	3 650	3 485	3 350	3 050	2.00
8 650				4 700	5 640	4 100	3 910	3 760	3 425	2.50	
9 600				5 220	6 260	4 550	4 340	4 175	3 800	3.00	
10 550				5 735	6 880	5 000	4 770	4 585	4 175	3.50	
11 500				6 250	7 500	5 450	5 200	5 000	4 550	4.00	
	GRIP-n-RIDE	155 A8	12 PR	6 440	3 500	4 200	3 050	2 910	2 800	2 550	1.40
7 075				3 845	4 615	3 350	3 200	3 075	2 800	1.60	
7 705				4 190	5 025	3 650	3 485	3 350	3 050	1.80	
8 340				4 530	5 440	3 950	3 770	3 625	3 300	2.00	
8 915				4 845	5 815	4 225	4 030	3 875	3 525	2.20	
	TI-06	156 A8	12 PR	5 200	2 825	3 390	2 465	2 350	2 260	2 055	1.10
5 795				3 150	3 780	2 745	2 620	2 520	2 295	1.30	
6 360				3 455	4 150	3 015	2 875	2 765	2 515	1.50	
6 900				3 750	4 500	3 270	3 120	3 000	2 730	1.70	
7 420				4 030	4 840	3 515	3 355	3 225	2 935	1.90	
7 935				4 315	5 175	3 760	3 590	3 450	3 140	2.10	
8 570				4 655	5 590	4 060	3 875	3 725	3 390	2.30	
9 200	5 000	6 000	4 360	4 160	4 000	3 640	2.50				
	TI-06	152 A8	12 PR	4 360	2 370	2 845	2 065	1 970	1 895	1 725	1.10
4 970				2 700	3 240	2 355	2 245	2 160	1 965	1.30	
5 590				3 040	3 645	2 650	2 525	2 430	2 210	1.50	
6 130				3 330	4 000	2 905	2 770	2 665	2 425	1.70	
6 670				3 625	4 350	3 160	3 015	2 900	2 640	1.90	
7 050				3 830	4 600	3 340	3 190	3 065	2 790	2.10	
7 245				3 940	4 725	3 435	3 275	3 150	2 865	2.20	
7 705				4 190	5 025	3 650	3 485	3 350	3 050	2.40	
8 165				4 440	5 325	3 870	3 690	3 550	3 230	2.60	
	TG-01	151 A6	12 PR	7 055	3 834	4 601	3 345	3 195	3 067	2 791	2.30
7 253				3 942	4 730	3 440	3 285	3 154	2 870	2.40	
7 452				4 050	4 860	3 535	3 375	3 240	2 948	2.50	
7 651				4 158	4 990	3 630	3 465	3 326	3 027	2.60	

Construction Applications Diagonal Tyres (continued)

Technical data and load capacities

Tyre size	Tread pattern Type	Rim (permitted)	New		Max. in service		Loaded static radius (mm)	Rolling circumference (mm)	Tread depth (mm)
			Overall diameter (mm)	Section width (mm)	Overall diameter (mm)	Overall width (mm)			
440/80-30 IND (16.9-30)	TI-09 TL	W15L×30 (W14L×30)	1 460	429	1 500	463	685	4 300	34

Variation in load capacity with speed dependence

Speed (km/h)	0	5	10	15	20	25	30	35	40	45	50
Constant load	+ 130%	+ 45%	+ 25%	+ 13%	+ 9%	+ 6%	+ 4%	+ 2%	(0)	- 4%	- 9%
Cyclic application	+ 130%	+ 67%*	+ 50%**	+ 34%	+ 23%	+ 11%	+ 7%	+ 3%	(0)	- 4%	- 9%

* One way distance 150 m.

** One way distance 600 m.



TI-09

Tread pattern	Service description L/SS	Ply rating	Tyre load capacity (kg) at speed (km/h)								Tyre pressure (bar)
			Static	10	10 cyclic	20	30	40	50		
TI-09	154 A8	14 PR	4 740	2 575	3 090	2 245	2 140	2 060	1 870	1.10	
			5 245	2 850	3 420	2 485	2 370	2 280	2 070	1.30	
			5 750	3 125	3 750	2 725	2 600	2 500	2 275	1.50	
			6 325	3 435	4 125	2 995	2 860	2 750	2 500	1.70	
			7 095	3 855	4 625	3 360	3 205	3 085	2 805	2.00	
			7 475	4 060	4 875	3 540	3 380	3 250	2 955	2.20	
			7 995	4 340	5 210	3 785	3 610	3 475	3 160	2.50	
			8 315	4 515	5 420	3 940	3 755	3 615	3 285	2.70	
			8 625	4 685	5 625	4 085	3 900	3 750	3 410	2.90	



Excellent traction

SK-01

Standard tread pattern with good traction properties and sidewall protection.



Reinforced construction

SK-02

Heavy duty tread pattern, robust reinforced tread lug in the central part, higher resistance to puncture and tread wear. Reinforced sidewall.



Longer service life

SK-05

Robust tyre for extreme conditions. Low void ratio and improved depth increases service life. Excellent self-cleaning properties.



Longer service life

BIG BOY

Robust industrial pattern with higher resistance to puncture and tread wear.



Excellent traction

TR-10 (R-4)

Tread pattern suitable above all for bigger skid steer loaders and front axles of backhoe loaders or telescopic platforms.



Skid steer diagonal tyres

For small machines
with great performance

Tyre size	SK-01	SK-02	SK-05	BIG BOY	TR-10
23×8.50-12		•			
27×8.50-15		•			
27×10.50-15		•			
31×15.5-15		•			
10.0/75-15.3 IND	•				
10-16.5		•	•	•	
12-16.5		•	•	•	
14-17.5 IND					•
10.5/80-18				•	
12.5/80-18				•	



SK series

Technical data and load capacities

Tyre size	Tread pattern Type	Rim (permitted)	Tube Flap	New		Max. in service		Loaded static radius (mm)	Rolling circumference (mm)	Tread depth (mm)	
				Overall diameter (mm)	Section width (mm)	Overall diameter (mm)	Overall width (mm)				
23×8.50-12	SK-02 TL	7.00×12	–	575	214	589	231	258	1 690	13	
27×8.50-15	SK-02 TL	7.00×15	–	680	214	695	231	317	2 000	14.5	
27×10.50-15	SK-02 TL	8.50×15	–	683	264	693	268	320	2 140	14.5	
31×15.5-15	SK-02 TL	13LB×15	–	766	384	800	405	360	2 371	23	
10.0/75-15.3 IND	SK-01 TT/TL	9.00×15.3	10-15 HS 10/75-15	780	264	800	277	360	2 295	17	



	Tread pattern	Service description LI/SS	Ply rating	Tyre load capacity (kg) at speed (km/h)						Tyre pressure (bar)
				10	15	20	30	40	50	
	SK-02	99 A4	6 PR	505	470	420	400			1.25
550				515	460	435			1.50	
650				605	540	515			1.75	
745				695	620	590			2.00	
840				785	700	665			2.25	
930		870	775	735			2.50			
1 050		980	875	831			2.80			
1 134		1 058	945	898			3.00			
1 212		1 131	1 010	960			3.20			
1 338		1 249	1 115	1 059			3.50			
1 458	1 361	1 215	1 154			3.80				
	SK-02	99 A4	6 PR	610	570	510	485			1.50
700				655	585	555			1.75	
790				740	660	625			2.00	
865				805	720	685			2.25	
930				870	775	735			2.50	
990		925	825	780			2.75			
1 050		985	880	835			3.00			
1 110		1 040	925	875			3.25			
1 170		1 095	975	925			3.50			
1 230		1 150	1 025	970			3.75			
1 290	1 200	1 070	1 015			4.00				
1 320	1 235	1 100	1 045			4.20				
	SK-02	120 A2	8 PR	1 100	850	740	700			3.00
1 170				900	790	750			3.25	
1 240				950	820	800			3.50	
1 300				1 000	860	850			3.75	
1 350				1 050	920	900			4.00	
1 400	1 110	990	940			4.20				
	SK-02	119 A4	8 PR	1 420	1 190	1 135	1 010			2.50
1 535				1 285	1 225	1 090			2.75	
1 690	1 410	1 350	1 200			3.10				
	SK-01	127 A6	10 PR	1 430	1 355	1 300	1 180			3.00
1 505				1 430	1 370	1 245			3.25	
1 585				1 505	1 440	1 310			3.50	
1 665				1 580	1 515	1 375			3.75	
1 745				1 655	1 585	1 440			4.00	
1 815				1 725	1 650	1 500			4.25	
1 890				1 800	1 720	1 565			4.50	
1 970				1 870	1 790	1 625			4.75	
2 045				1 945	1 860	1 690			5.00	
2 120				2 015	1 925	1 750			5.25	

SK series (continued)

Technical data and load capacities

Tyre size	Tread pattern Type	Rim (permitted)	Tube Flap	New		Max. in service		Loaded static radius (mm)	Rolling circumference (mm)	Tread depth (mm)
				Overall diameter (mm)	Section width (mm)	Overall diameter (mm)	Overall width (mm)			
10-16.5	SK-02 TL	8.25×16.5	–	773	264	792	285	345	2 340	22
	SK-05 TL	8.25×16.5	–	805	259	840	280	366	2 355	35
	BIG BOY TL	8.25×16.5	–	798	259	832	280	366	2 355	19
12-16.5	SK-02 TL	9.75×16.5	–	831	307	851	331	370	2 515	22
	SK-05 TL	9.75×16.5	–	836	305	873	329	384	2 475	35
	BIG BOY TL	9.75×16.5	–	841	315	879	340	384	2 475	20.6
14-17.5 IND	TR-10 TL	10.50×17.5	–	910	355	932	383	430	2 858	22
10.5/80-18	BIG BOY TL	9×18	–	907	274	927	292	411	2 645	26
12.5/80-18	BIG BOY TL	9×18	–	991	307	1 014	323	445	2 865	28



	Tread pattern	Service description LI/SS	Ply rating	Tyre load capacity (kg) at speed (km/h)					Tyre pressure (bar)	
				10	15	20	30	40		50
	SK-02 BIG BOY	131 A3	8 PR	1 640	1 530	1 365	1 195			2.50
				1 730	1 615	1 440	1 265			2.75
	SK-02 SK-05	135 A3	10 PR	1 825	1 700	1 520	1 335			3.00
				1 915	1 785	1 595	1 400			3.25
	SK-02 BIG BOY	140 A3	10 PR	2 005	1 870	1 670	1 465			3.50
				2 090	1 950	1 740	1 525			3.75
	SK-02 SK-05 BIG BOY	144 A3	12 PR	2 100	1 960	1 750	1 540			4.50
				2 215	2 070	1 845	1 645			4.75
	BIG BOY	147 A3	14 PR	2 330	2 180	1 945	1 710			5.00
				2 075	1 935	1 730	1 520			2.50
	SK-02 BIG BOY	140 A3	10 PR	2 210	2 060	1 840	1 615			2.75
				2 330	2 170	1 940	1 700			3.00
	SK-02 SK-05 BIG BOY	144 A3	12 PR	2 440	2 280	2 035	1 785			3.25
				2 525	2 360	2 105	1 845			3.50
	BIG BOY	147 A3	14 PR	2 575	2 400	2 145	1 880			4.00
				2 635	2 450	2 195	1 925			4.25
	TR-10	139 B	14 PR	2 690	2 500	2 240	1 965			4.50
				2 775	2 570	2 310	2 035			4.75
	BIG BOY	115 A8	10 PR	2 860	2 650	2 385	2 100			5.00
				2 960	2 740	2 460	2 165			5.25
	BIG BOY	128 A8	14 PR	3 025	2 800	2 520	2 220			5.50
				3 120	2 890	2 600	2 290			5.75
	BIG BOY	115 A8	10 PR	3 220	2 980	2 680	2 360			6.00
				3 320	3 075	3 010	2 650			6.20
	TR-10	139 B	14 PR	2 760	2 575	2 480	2 205	1 970	1 775	3.20
				2 890	2 700	2 600	2 315	2 065	1 860	3.50
	BIG BOY	115 A8	10 PR	3 030	2 830	2 730	2 425	2 165	1 950	3.80
				3 165	2 950	2 850	2 530	2 260	2 035	4.10
	BIG BOY	128 A8	14 PR	3 345	3 150	3 010	2 675	2 390	2 150	4.50
				3 565	3 320	3 205	2 850	2 545	2 290	5.00
	BIG BOY	128 A8	14 PR	3 780	3 550	3 400	3 025	2 700	2 430	5.50
				1 290		1 160	1 030	920	875	2.80
	BIG BOY	128 A8	14 PR	1 430		1 285	1 145	1 020	970	3.10
				1 560		1 405	1 250	1 115	1 060	3.40
	BIG BOY	128 A8	14 PR	1 700		1 530	1 360	1 215	1 155	3.70
				1 750		1 575	1 400	1 250	1 190	2.50
	BIG BOY	128 A8	14 PR	1 960		1 765	1 570	1 400	1 330	2.80
				2 170		1 955	1 735	1 550	1 475	3.10
	BIG BOY	128 A8	14 PR	2 270		2 040	1 815	1 620	1 540	3.40
				2 350		2 120	1 880	1 680	1 595	3.70
	BIG BOY	128 A8	14 PR	2 435		2 190	1 950	1 740	1 655	4.00
				2 520		2 270	2 015	1 800	1 710	4.30



Good stability

FL-08



Bias pneumatic – medium intensity applications

Strives to deliver optimum performances in various service conditions

Block tread design – improve traction performance.

Enhanced stability – tread pattern specifically designed to improve directional stability.

Shock absorbance – heavy duty service.



STABILITY



TYRE LIFE



COOL RUNNING



FL-08

Technical data and load capacities

Tyre size (Alternative size)	Type	Rim (permitted)	Section width (mm)	Overall diameter (mm)	Minimal dual spacing (mm)
4.00 - 8	TT	3 1/4I - 8	112	414	138
15×4.5 - 8	TT	3.00D - 8	117	381	140
5.00 - 8	TT	3.00D - 8	132	467	158
16×6 - 8 (150/75 - 8)	TT	4.33R - 8	152	425	175
18×7 - 8 (180/70 - 8)	TT	4.33R - 8	173	462	199
6.00 - 9	TT	4.00E - 9	160	540	192
21×8 - 9 (200/75 - 9)	TT	6.00E - 9	200	535	230
6.50 - 10	TT	5.00F - 10 (5.50F - 10)	177	588	212 (218)
7.50 - 10	TT	5.00F - 10	205	643	242
23×9 - 10 (225/75 - 10)	TT	6.50F - 10	225	595	259
7.00 - 12	TT	5.00S - 12	192	672	230
23×10 - 12	TT	8.00G - 12	243	594	293
27×10 - 12 (250/75 - 12)	TT	8.00G - 12	261	681	293
7.00 - 15	TT	5.50 - 15	198	748	236
7.50 - 15	TT	6.0 - 15 (6.5 - 15)	212	772	254 (260)
8.15 - 15 (28×9 - 15)	TT	7.0 - 15	216	707	248
8.25 - 15	TT	6.5 - 15	234	836	281
250 - 15 (250/70 - 15)	TT	7.50 - 15	250	735	288
28×12.5 - 15	TT	9.75 - 15	274	727	326
300 - 15 (315/70 - 15)	TT	8.00 - 15	300	840	345

For dual application the loads are 88% of single tyre.



	Tread depth (mm)	Service description LI/SS	Ply Rating	Tyre load capacity (kg)		Tyre pressure (bar)
				Load wheel	Steering wheel	
	6	94 A5	8 PR	870	670	9.00
		97 A5	10 PR	950	730	10.00
	8	100 A5	12 PR	1 040	800	10.00
	11	106 A5	8 PR	1 235	950	8.25
		111 A5	10 PR	1 415	1 090	10.00
	12	113 A5	16 PR	1 495	1 150	10.00
	14	121 A5	14 PR	1 885	1 450	9.00
		125 A5	16 PR	2 145	1 650	10.00
	13	118 A5	10 PR	1 715	1 320	8.50
		121 A5	12 PR	1 885	1 450	10.00
	15	131 A5	14 PR	2 535	1 950	9.00
		134 A5	16 PR	2 755	2 120	10.00
	14	122 A5	10 PR	1 950	1 500	7.75
		125 A5	12 PR	2 145	1 650	9.00
		128 A5	14 PR	2 340	1 800	10.00
	15	133 A5	12 PR	2 680	2 060	8.00
	16	142 A5	20 PR	3 340	2 650	10.00
	15	133 A5	12 PR	2 680	2 060	8.50
		134 A5	14 PR	2 755	2 120	9.00
		136 A5	16 PR	2 910	2 240	10.00
	20	139 A5	16 PR	3 160	2 430	8.00
	18	143 A5	14 PR	3 545	2 725	7.00
		146 A5	16 PR	3 900	3 000	8.00
		152 A5	20 PR	4 615	3 550	10.00
	17	140 A5	14 PR	3 250	2 500	9.25
	21	144 A5	14 PR	3 640	2 800	9.25
		146 A5	16 PR	3 900	3 000	10.00
	18	146 A5	14 PR	3 900	3 000	10.00
	23	149 A5	14 PR	4 225	3 250	8.00
		153 A5	18 PR	4 745	3 650	10.00
	20	153 A5	18 PR	4 745	3 650	9.50
		155 A5	20 PR	5 040	3 875	10.00
	17	151 A5	20 PR	4 535	3 490	9.00
	23	164 A5	20 PR	6 500	5 000	9.00
		165 A5	22 PR	6 695	5 150	10.00



Good stability

FL-03

HANDLING	██████████
RESISTANCE	██████████
SERVICE LIFE	██████████



FL-07

HANDLING	██████████
RESISTANCE	██████████
SERVICE LIFE	██████████

Material Handling diagonal tyres

Good handling in various service conditions

Tyre size	FL-03	FL-07	FL-08
4.00-8	•		•
15×4.5-8			•
5.00-8	•		•
16×6-8 (150/75-8)			•
18×7-8 (180/70-8)			•
6.00-9			•
21×8-9 (200/75-9)			•
6.50-10			•
7.50-10			•
23×9-10 (225/75-10)			•
7.00-12			•
23×10-12			•
27×10-12 (250/75-12)			•
23×5		•	
7.00-15			•
7.50-15			•
8.15-15 (28×9-15)			•
8.25-15			•
250-15 (250/70-15)			•
28×12.5-15			•
300-15 (315/70-15)			•

Counterbalanced lift trucks application		Maximum tyre load capacity (% of reference load)
25 km/h	Load wheel	130
	Steering wheel	100
35 km/h	Load wheel	125
	Steering wheel	92.5
Side-loaders application		Maximum tyre load capacity (% of reference load)
Static		151
25 km/h		100
35 km/h		92.5
Other vehicles application		Maximum tyre load capacity (% of reference load)
10 km/h		130
25 km/h		100
40 km/h		89
50 km/h		84

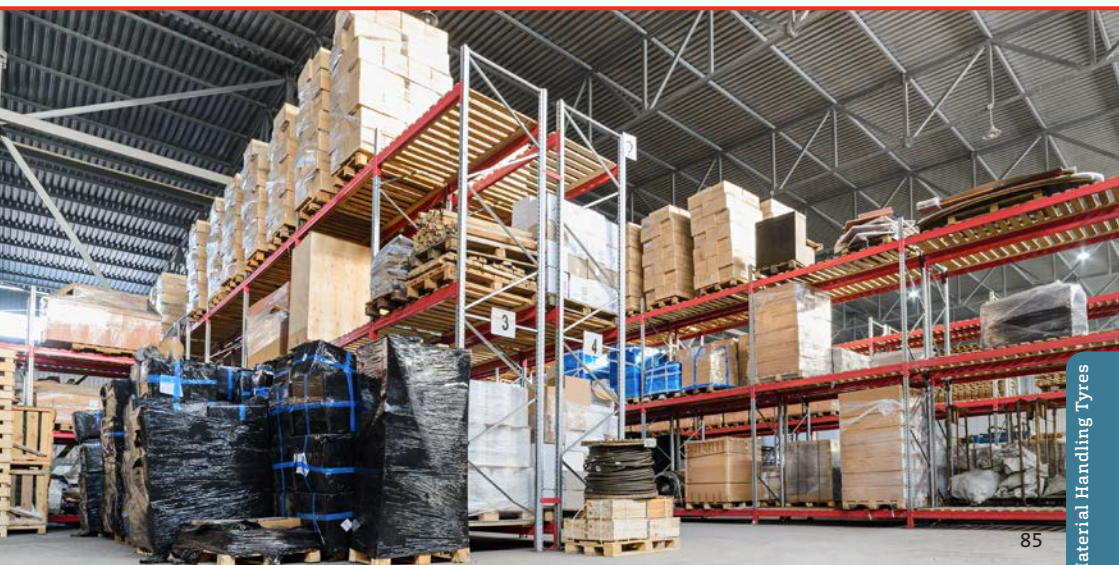

FL series

Technical data and load capacities

Tyre size	Tread pattern	Type	Rim (permitted)	Tube Flap	New		Max. in service		Loaded static radius (mm)	Minimal dual spacing (mm)
					Overall diameter (mm)	Section width (mm)	Overall diameter (mm)	Overall width (mm)		
4.00 - 8	FL-03	TT	3.00D-8 3 1/4I-8 *	4.00 - 8	414	112	422	121	188	134 138
5.00 - 8	FL-03	TT	3.00D-8	5.00 - 8	467	132	476	143	208	158
23 x 5	FL-07	TT	3.75P-13	23 x 5	635	155	654	167	290	186

* obligatory for 8 PR and 10 PR



	Tread depth (mm)	Tread pattern	Service description LI/SS	Ply rating	Tyre load capacity (kg)		Tyre pressure (bar)
					Load wheel	Steering wheel	
	6	FL-03	90 A5	6 PR	780	600	8.00
			94 A5	8 PR	870	670	9.00
			97 A5	10 PR	950	730	10.00
	6	FL-03	106 A5	8 PR	1 235	950	8.25
	9.5	FL-07	113 A5	6 PR	1 495	1 150	5.25
			121 A5	10 PR	1 885	1 450	8.00

Use & Maintenance

Storage

- > Keep the tyres clean and away from heat, light, ozone or hydrocarbon sources.
- > Avoid prolonged exposure of the tyres to direct sunlight.
- > Avoid any contact with grease, petrol, volatile solvents or other substances that may deteriorate the rubber.
- > Avoid horizontal storage for tubeless tyres, only small size tyres may be stacked or stored flat (maximum 6 months).
- > When tyres are stored flat (horizontal), the position must be lug against lug.
- > Reduce inflation pressure when tyres are stored fitted on rims.
- > Ensure there is no water or moisture inside the tyre.
- > Never store tyres directly in contact with the ground for long periods.

Tyre repairs

- > For safety reasons, repairs should only be carried out by specialists using the correct tools.

Proper use of tyres

- > When loading tyres you have to consider the correlation between speed, inflation pressure and load capacity.
- > Overloading results in premature tyre failure. Use the technical documentation and inflation tables which show the load and pressure figures for different operating speeds.
- > Underinflation results not only in incorrect tread wear but also in ply separation and eventually further damage to the ply.
- > Overinflation makes the tyre stiff and decreases its resistance against hits, leading to ply tear.



Check inflation pressure regularly



Avoid contact with grease, oil and other chemicals



Inspect tyres for damage and irregularities



Observe tyre and vehicle load limits



Read safety and maintenance recommendations



Use only authorised repair

Fitting and removal instructions

Demounting and mounting procedures can be dangerous, and should be performed only by trained and qualified staff, using proper tools and procedures. Failure to comply with these procedures may result in faulty positioning of the tyre on the rim, and cause the tyre to burst with explosive force leading to serious physical injury or death.

Fitting

1. Make sure that the rim, the tyre and the tube are compatible.
2. Check that the tyre is suitable for the machine. Use only rims recommended or permitted by the tyre manufacturer.
3. Always use the proper specialised equipment and tools.
4. The rim must be clean and in perfect condition (no damage, etc.). If necessary, clean the rim thoroughly with a wire brush. Never fit a tyre onto a rim that shows cracks, significant distortion, evidence of welded repair, etc.
5. Thoroughly inspect the inside as well as the outside of the tyre in order to identify any damage which may be present. If the damage is considered to be beyond repair, the tyre should be scrapped.
6. If fitting with a tube, always use the correct new tube and flap for the tyre size. For fitting tubeless tyres without tubes, on tubeless rims, always use a new tubeless valve.
7. Before fitting, lubricate the rim and the beads. Use only a suitable lubricant that will not damage the tyre (never use silicone or petroleum-based products).
8. We recommend vertical fitting. In case of horizontal fitting it is impossible to see if the lower bead is correctly seated.
9. Fit the tyre on the rim diametrically opposite to the valve hole (respect, if present, the rotation direction indicated by the arrows). With the help of a suitable lever and closely repeated applications, get the first bead over the rim flange. Then pose the lightly inflated talc coated tube (if fitted) inside the tyre. Locate the valve, fitting the ferrule loosely. Fit the second bead, lever it progressively over the rim flange, finish at the valve.
10. For seating the beads and centring of the tyre, remove the valve core. Slowly inflate to ensure correct seating of the beads. Ensure that the beads do not pinch the tube.
11. During tyre inflation keep at a safe distance and always use a safety cage. If possible, fasten the tyre to the wall or use retaining chains. During pressure readings ensure that no part of the body is within the possible trajectory of the valve mechanism or of the caps. It is recommended to use suitable pressure limitation gauges. Use a filter and dehumidifier on the compressed air line to avoid introducing humidity or dirt. Never use a hammer to make a tyre bead seat by hitting it.
12. Continue inflation. Make sure that you do not inflate beyond 2.5 bar if the beads are not well seated and centred on the wheel.
13. If the beads are not correctly seated, deflate, lubricate and inflate again. Repeat these operations until the beads are correctly seated.
14. When all the previous operations have been correctly done refit the valve core. Set the pressure according to the load – see tables in technical databook.
15. Make sure the valves do not touch the rims, the brake drums or other fixed mechanical parts.

Removing

- > Never try to unseat the beads of an inflated tyre.
- > Always remove the valve core.
- > Let the tyre deflate, check before unseating that the tyre is completely deflated. Never use tools that could damage the rims or the beads of the tyre.

Earthmover tyres

“L” series type tyres

“L” series type tyres are used on all size loaders and dozers in off-road applications. Most loader type tyres, because of their extremely heavy construction, are limited to very low speeds and very short haul distances, 10 km/h and 250 m maximum.

Wheeled Loader



Loader Service: Closed working cycle
Low speed – up to 10 km/h
Short distance – up to 250 m

Load and Carry Service: Picks up and transports material
Low speed – up to 25 km/h
Short distance – cycle length up to 600 m

Wheeled Dozer



Dozer Service: Pushes or grades material
Low speed – up to 10 km/h
Travel distance varies

“L” series tyres are categorized by **number code**, **type** and **tread depth**.

Number code	Type	Tread depth
L-2	Traction Design	Regular Tread Depth
L-3	Rock Design	Regular Tread Depth

Below are examples of Mitas “L” Series tyres



The letter designation and number code is found on the sidewalls of tyres.
The **L-2** traction design tyre gives maximum traction in sand and soft soil conditions.
The **L-3** rock design offers good traction and rock resistance in general purpose loader operations.

These illustrations show different lug to void ratios.

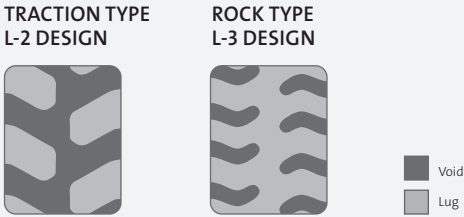

MITAS has also developed comparison ratings for “L” series type tyres.

Note: The numbers are relative ratings with the L-3 tyre rated at 100. For example, the L-2 tyre has 20% better traction than the L-3. Certain tyre construction features and applications can affect these ratings.

The data below could vary from operation and /or from size to size of tyre.

“L” series tyres				
	Traction	Rock resistance	Tread wear	Lug to Void ratio
L-2	120	90	90	1 : 1
L-3	100	100	100	1 : 2

Determining Inflation Pressures for Loaders

1 – By weighing the machine axle

- Determine the maximum load on each tyre by weighing, this is the only way of setting tyre pressures accurately for optimum performance
- Use the table “Variation in load capacity with speed” for LOADERS to determine the pressure
Front axle: for laden front axle (bucket full)
Rear axle: for unladen rear axle (bucket empty)

2 – By calculation, using the machine manufacturer’s data

When the machine is loading with the bucket penetrating into the material, the loader is often on the point of tipping.

It is in this state that the front tyres are most heavily laden.

- Determine the maximum load /tyre on the front and rear axles

FRONT axle

The load on the front axle is equal to the total unladen weight of the machine + the tipping load (tipping load is shown in machine manufacturer’s data).

REAR axle (bucket empty)

- Use either the unladen rear axle load given by the machine manufacturer, or
- Take 60% of the unladen weight of the machine (to have a margin of safety)

Earthmover tyres (continued)

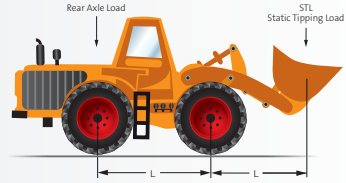

Example calculation (for a loader with the following characteristics):

Tyre equipment:	23.5 - 25 16 PR EM-30 TL		
Unladen weights:	Front:	8 000 kg (1)	
	Rear:	8 500 kg (2)	
	Total:	16 500 kg (3)	
Straight line tipping load:		13 900 kg (4)	

Maximum axle load – Front (static*)
(3) + (4) = 30 400 kg or 15 200 kg per tyre

Maximum axle load – Rear
(2) = 8 500 kg or 4 250 kg per tyre

Base pressures as per table “Variation in load capacity with speed”

Front = 300 kPa (* increase for static load from 10 km/h is 60 %, $15\,200 / 1.6 = 9\,500$ kg)

Rear = 250 kPa (calculated with a margin of safety for speed 25 km/h)

Important

The rule to determine pressures by calculation applies to loaders of standard specifications, which have not been modified for special use. The calculated pressures are the minimum for the loads and may be increased to obtain a desired level of handling, or for particular applications, (but must remain within the published load / pressure schedule for the tyre size and type). In the case of long travel distances (e.g. delivery of new machine, transfer from one site to another, etc.), specific precautions need to be taken:

Vehicles in Transit

- Vehicles must be empty during transit
- Set inflation pressure on cold tyres to the maximum value permitted by the table “Variation in load capacity with speed” for loaders
- Maximum vehicle speed 35 km/h
- Cooling stop 30 minutes after each 50 km transit
- Transit to a distance longer than 100 km is not recommended and the vehicle must be transported on a trailer

The inflation pressure will increase during roading of the vehicles. The pressure must not be lowered when tyres are warm.

Determining Inflation Pressures for Dozers:

Depending on the type of work, tyres on a dozer are subjected to different types of loading.

- The load on the Front Axle is maximum when loading (pushing) a scraper
- The load on the Rear Axle is maximum when dozing or whilst stockpiling

From a practical viewpoint, the maximum load on either of the two axles is approximately equal to 2/3 of the machine weight.

- Using this method determine the load on each tyre
- Use the table “Variation in load capacity with speed”

Determining Inflation Pressures for Telescopic Handlers

In the case of telescopic handlers the pressures recommended by the machine manufacturer should be used. These pressures are determined by the machine manufacturer after conducting a “Tilt Test” for stability. In the absence of the machine manufacturer’s recommendation, use the pressure corresponding to the maximum normalised load as shown in the table “Variation in load capacity with speed” for LOADERS for both front and rear tyres.

List of homologations

Inch	Tyre size	Alternative tyre size	Tread pattern	DOT 119	ECE R.54	M + S	ECE R.106	ECE R.117	EC 2001/43
EM Diagonal Tyres									
20"	500/45-20		TI-12				•		
22.5"	500/60-22.5		TI-12				•		
	600/40-22.5		TI-12				•		
Light Equipment Diagonal Tyres									
18"	280/80-18	(10.5-18)	MPT-01				•		
	10.5-18		MPT-02				•		
	340/80-18	(12.5-18)	MPT-01				•		
19.5"	18-19.5		MPT-03					•	
20"	340/80-20	(12.5-20)	MPT-01				•		
	16/70-20	(405/70-20)	MPT-02				•		
	405/70-20	(16/70-20)	MPT-01				•		
24"	405/70-24	(16/70-24)	MPT-01				•		
Crane Radial Tyres									
25"	385/95 R 25		CR-01	•	•	•			
	445/95 R 25		CR-01	•	•	•			
	445/95 R 25		CR-02	•	•	•			
	525/80 R 25		CR-01	•	•	•			
MPT Radial Tyres									
18"	335/80 R 18	(12.5 R 18)	EM-02	•	•	•			•
20"	335/80 R 20	(12.5 R 20)	MPT-20	•	•	•			•
	335/80 R 20	(12.5 R 20)	MPT-21	•	•	•			•
	365/80 R 20	(14.5 R 20)	MPT-20	•	•	•			•
	365/80 R 20	(14.5 R 20)	MPT-21	•	•	•			•
	405/70 R 20	(16/70 R 20)	MPT-21	•	•	•			•
22.5"	275/90 R 22.5		SRT2	•	•	•	•	•	•
	375/75 R 22.5		MPT-23	•	•	•			•
24"	405/70 R 24	(16/70 R 24)	MPT-21	•	•	•			•
	445/70 R 24	(17.5L R 24)	MPT-22	•	•	•			•
MPT Diagonal Tyres									
18"	12.5-18		MPT-03	•	•	•			•
20"	10.5-20		MPT-05	•	•	•			•
	10.5-20		MPT-07	•	•	•			•
	12.5-20		MPT-03	•	•	•			•

Inch	Tyre size	Alternative tyre size	Tread pattern	DOT 119	ECE R.54	M + S	ECE R.106	ECE R.117	EC 2001/43
	12.5-20		MPT-05		•	•			•
	14.5-20		MPT-03		•	•			•
	14.5-20		MPT-05		•	•			•
	16/70-20	(405/70-20)	MPT-05		•	•			•
	405/70-20	(16/70-20)	MPT-03		•	•			•
Tractor Industrial Radial Tyres									
18"	340/80 R 18 IND		TI-20				•		
24"	460/70 R 24 IND	(17.5L R 24)	TI-22				•		
26"	480/80 R 26 IND		TI-20				•		
28"	440/80 R 28 IND		TI-20				•		
Construction Applications Diagonal Tyres									
18"	320/80-18 IND	(12.5/80-18)	TR-09				•		
	340/80-18 IND	(12.5-18)	MPT-04				•		
20"	280/80-20 IND	(10.5-20)	MPT-04				•		
	340/80-20 IND	(12.5-20)	MPT-04				•		
	360/85-20 IND	(14.5-20)	MPT-04				•		
	400/70-20 IND	(16.0/70-20)	MPT-04				•		
	400/75-20 IND	(16.0/70-20)	TR-09				•		
22.5"	480/65-22.5 IND	(18-22.5)	MPT-06				•		
24"	400/70-24 IND		MPT-04				•		
	400/80-24 IND	(15.5/80-24)	TI-05				•		
	16.9-24 IND		TI-04				•		
	16.9-24		TG-01				•		
	17.5L-24 IND		TI-02				•		
	460/70-24 IND	(17.5L-24)	TI-05				•		
	19.5L-24 IND		TI-05				•		
	19.5L-24 IND		GRIP-n-RIDE				•		
	500/70-24 IND	(19.5L-24)	TI-05				•		
	21L-24 IND		GRIP-n-RIDE				•		
26"	18.4-26 IND		TI-06				•		
28"	16.9-28 IND		TI-06				•		
	16.9-28		TG-01				•		
30"	440/80-30 IND	(16.9-30)	TI-09				•		

DOT 119 Nat'l Highway Traffic Safety Admin., DOT § 571.119 Standard No. 119; New pneumatic tyres for motor vehicles with a GVWR of more than 4 536 kilograms (10 000 pounds) and motorcycles.

ECE R.54 European Regulation No. 54; Uniform provisions concerning the approval of pneumatictyres for commercial vehicles and their trailers.

M + S Mud & Snow Pattern

ECE R.106 European Regulation No. 106; Uniform provisions concerning the approval of pneumatictyres for agricultural vehicles and their trailers.

ECE R.117 European Regulation No. 117; Uniform provisions concerning the approval of tyres with regard to rolling sound emissions and to adhesion on wet surfaces and/or to rolling resistance.

EC 2001/43 European Directive 2001/43/EC relating to tyres for motor vehicles and their trailers and to their fitting; noise from tyres.

Rim specification

Sample of rim marking

DW18L x 38	Meaning
DW	Rim Contour
18	Nominal Rim Width in inches
L	Flange Height code
x	One-piece rim
38	Nominal Rim Diameter in inches

Further samples of marking

	Meaning
W	Wide Drop Centre – Single Well shape rim
DW	Wide Drop Centre – Double Well shape rim
SDC	Semi-drop Centre rim
–	Multi-piece rim
x	One-piece rim
H2	Double Hump
DC	Drop Centre rim

5° Drop Centre rims

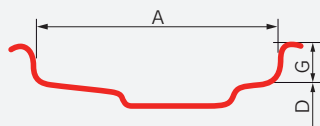

RIM	A	G	D
9.00 x 15.3	228.6	19.0	388.8
9 x 18	228.6	25.4	462.0
11 x 18	279.4	25.4	462.0
12 x 18	304.8	25.4	462.0
13 x 18	330.2	25.4	462.0
9 x 20	228.6	25.4	512.8
11 x 20	279.4	25.4	512.8
12 x 20	304.8	25.4	512.8
13 x 20	330.2	25.4	512.8
16.0 x 20	406.5	25.5	512.8
13 x 24	330.2	25.4	614.4
13.0 x 24	330.2	25.4	614.4

15° Drop Centre rims

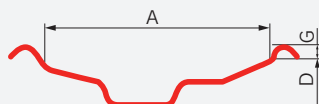

RIM	A	G	D
8.25 x 16.5	209.6	12.7	419.1
9.75 x 16.5	247.6	12.7	419.1
10.50 x 17.5	266.5	12.7	444.5
13.00 x 19.5	330.2	12.7	495.3
8.25 x 22.5	209.5	12.7	571.5
11.75 x 22.5	298.5	12.7	571.5
14.00 x 19.5	355.6	12.7	495.3
16.00 x 22.5	406.4	12.7	571.5
20.00 x 22.5	508.0	12.7	571.5

5° Full Tapered rims

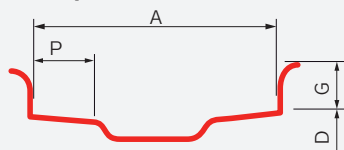

RIM	A	G	D
11.25/2.0 - 25	286.0	51.0	635.0
13.00/2.5 - 25	330.2	63.5	635.0
15.00/2.5 - 25	381.0	63.5	635.0
17.00/2.0 - 25	431.8	50.8	635.0
19.50/2.5 - 25	495.3	63.5	635.0
22.00/3.0 - 25	558.8	76.2	635.0
24.00/3.0 - 25	609.6	76.2	635.0
25.00/3.5 - 25	635.0	89.0	635.0
22.00/3.0 - 29	558.8	76.2	736.6
24.00/3.0 - 29	609.6	76.2	736.6
13.00/2.5 - 33	330.2	63.5	838.2

5° Tapered rims

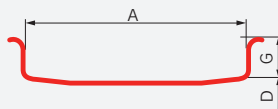

RIM	A	G	D
6.0 - 15	152.4	33.0	387.4
6.5 - 15	165.1	35.6	387.4
7.0 - 15	177.8	38.1	387.4
6.0 - 20	152.4	33.0	514.4
6.5 - 20	165.1	35.6	514.4
7.0 - 20	177.8	38.1	514.4
7.5 - 20	190.5	40.6	514.4
8.0 - 20	203.2	43.2	514.4
8.5 - 20	215.9	45.7	514.4
9.0 - 20	228.5	48.5	514.4

5° Full Tapered rims

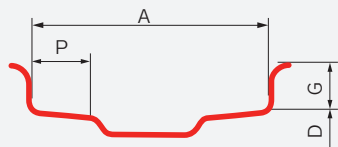

RIM	A	G	D
9.50/1.7 CR - 25	241.5	43.0	635.0
10.00/1.5 - 25	254.0	38.1	635.0
11.00/1.7 CR - 25	279.5	43.0	635.0
12.00/1.3 - 25	304.8	33.0	635.0
14.00/1.5 - 25	355.6	38.1	635.0
17.00/1.7 - 25	431.8	43.2	635.0

5° Semi-Drop Centre rims

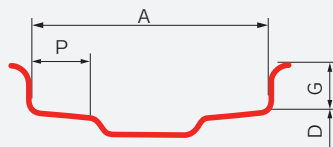

RIM	A	G	D
9×20 SDC	228.6	25.4	512.8
11×20 SDC	279.4	25.4	512.8
12×20 SDC	304.8	25.4	512.8
13×20 SDC	330.2	25.4	512.8
13×24 SDC	330.2	25.4	614.4
8.00 TG×24 SDC	203.2	35.7	614.4
16.00 T-24 SDC	406.4	35.7	614.4
10.00 VA×24 SDC	254.0	43.2	614.4

Rim specification (continued)

5° Drop Centre rims

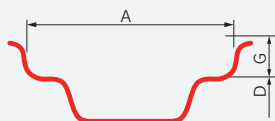

RIM	A	G	D
7.00×12	177.8	20.5	304.0
7.00×15	177.8	20.5	380.2
7 JA×15	177.8	16.0	380.2
8 J×15	203.0	17.3	380.2
8.50×15	216.0	17.3	380.2
13 LB×15	330.0	22.0	380.2
8 LB×16	203.0	22.0	405.6

5° Tapered rims

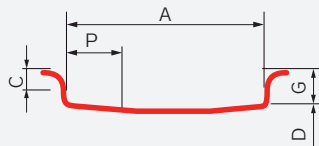

RIM	A	G	D
3.00 D-8	76.2	17.5	202.4
4.00 E-9	101.6	19.8	227.8
6.00 E-9	152.4	19.8	227.8
5.00 F-10	127.0	22.2	253.2
5.50 F-10	139.7	22.2	253.2
6.50 F-10	165.1	22.2	253.2
5.00 S-12	127.0	31.3	308.8
8.00 G-12	203.2	27.9	304.0

5° Drop Centre rims

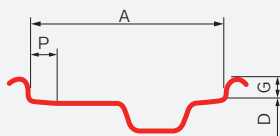

RIM	A	G	D
9.00/1.5-24	228.6	38.0	614.4
13.00/1.4-25	330.2	35.8	635.0
14.00/1.3-25	355.6	33.0	635.0

5° Tapered rims – Divided Type

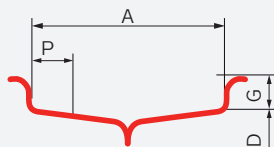

RIM	A	G	D
3 1/4 I-8	82.5	15.8	202.4
5.00 S-12	127.0	31.3	308.8

Flat Base rims – Divided Type

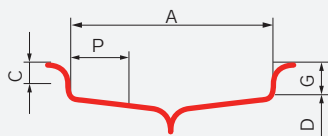

RIM	A	G	D
4.33 R-8	110.0	27.8	205.1

Flat Base rims

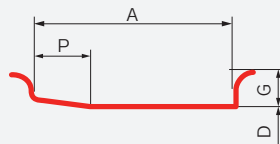

RIM	A	G	D
3.75 P-13	95.2	25.4	330.2
4.33 R-8	110.0	28.6	202.4

W and DW rims

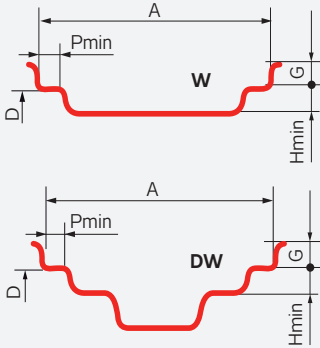

RIM	A	G	Pmin.	Hmin.
W 12	305.0	25.4	27.0	20.6
W 13	330.2	25.4	27.0	20.6
W 14 L	355.6	25.4	27.0	20.6
W 15 L	381.0	25.4	33.0	20.6
W 16 L	406.4	25.4	33.0	20.6
DW 13	330.2	25.4	27.0	20.6
DW 20 A	508.0	28.6	50.8	27.0
DW 14 L	355.6	25.4	36.5	27.0
DW 15 L	381.0	25.4	36.5	27.0
DW 16 L	406.4	25.4	50.5	27.0
DW 18	457.2	25.4	50.8	27.0
DW 20	508.0	28.6	41.3	27.0

Nominal	24"	26"	28"	30"
D	614.4	665.2	716.0	766.8

Terms and shortcuts used in this catalogue

Acronyms	Meaning	Definition
PR	Ply Rating	Identifies different versions (load capacity/inflation pressure) of tyres having the same size designation.
TYPE	Tubeless or Tube Type	Tubeless (TL) – Tyres specifically designed for fitment without an inner tube on appropriate rims. Tubeless tyres may be used with a tube.
LI	Load Index	Is a numerical code associated with the maximum load a tyre can carry at the speed indicated by its Speed Symbol under service conditions specified by the tyre manufacturer.
SS	Speed Symbol	Indicated the maximum speed at which the tyre can carry a load corresponding to its Load Index under service conditions specified by the tyre manufacturer.
	Free Rolling Wheels	Free rolling wheels, that not transmit motion, e.g. trailer.
	Drive Wheels	Drive wheels, that transmit motion, e.g. drive wheel axle on tractors.
RIM	Recommended Rim	The rim which gives the best fitment of the tyre for all conditions and types of service.
RIM (PERMITTED)	Permitted Rim	Any rim which can be permitted in addition to the recommended rim.
	New Tyre Dimensions	The dimensions of an unloaded new tyre mounted on its Measuring Rim at the recommended inflation pressure and allowed to stand for a minimum of 24 hours at normal room temperature before readjustment of the pressure back to its original level.
	Section Width (design)	The linear distance between the outsides of the sidewalls of an inflated new tyre excluding elevations due to labelling (marking), decorations, or protective bands or ribs.
	Overall Diameter (design)	The diameter of an inflated tyre at the outermost surface of the tread.
	Static Radius (theoretical nominal)	The radius of the new tyre loaded at the maximum load capacity and with the corresponding tyre pressure.
	Rolling Circumference (theoretical nominal)	The circumference of the tyre loaded at the maximum load capacity and with the corresponding tyre pressure.

Acronyms	Meaning	Definition
LOAD CAPACITY	Tyre Load Carrying Capacity	The maximum load (kg) a tyre is permitted to carry under specified operating conditions. In the case of twin-fitted driven wheels, a factor of 1.76 is applied to the load capacity of a single fitment tyre.
	Inflation Pressure	The “cold” pressure (kPa) of the fluid with which the tyre is inflated.
HLV	High Load Variation	Is where the tyre load varies by a factor of “2” or more between loaded and unloaded conditions. The inflation pressure for HLV application must be increased, consult tyre manufacturer. In the case of HLV, the maximum distance should not exceed 1 km and maximum speed 10 km/h. For a longer distance or higher speed, consult tyre manufacturer. Example of purpose: without HLV - normal use with constant load in transport service, on tractor in field service, e.g. trailer, tractor; with HLV – use with various load conditions, factor > 2 between loaded and unloaded, e.g. loaders.
LLV	Low Load Variation	Standard application with low load difference between loaded and unloaded conditions.
ETRTO	The European Tyre and Rim Technical Organisation	Data in this Technical Databook are relevant with ETRTO standards, the further data you can find there.
	Nominal Section Width	The section width of an inflated tyre mounted on its theoretical rim and indicated in the tyre size designation.
IND		Agricultural tyres for traction wheels for construction applications with load capacities and inflation pressures which differ from those for tyres which the same size designation for use on agricultural tractors.
REINFORCED		Tyres with better protection against tyre damage (puncture). The load capacity and tyre dimensions stay like standard execution.

Yokohama TWS Czech Republic a.s.

Švehlova 1900/3, 106 00 Prague 10, Czech Republic



Yokohama TWS Czech Republic a.s. is fully compliant with the limits on Polycyclic AromaticHydrocarbons (PAHs) determined by the European Directive EC/2005/69 and REACH Regulation EC/1907/2006, since December 1st 2009.

© Yokohama TWS: 6/23_1/1 / Magic Seven



Your Distributor/Dealer:

Mitas

mitas-tyres.com